

<p>CEMP-R Design Guide 1110-1-1</p>	<p>Department of the Army U.S. Army Corps of Engineers Washington, DC 20314-1000</p>	<p>DG 1110-1-1 12 November 1999</p>
	<p>Engineering and Design DESIGN GUIDANCE FOR GROUND WATER/FUEL EXTRACTION AND GROUND WATER INJECTION SYSTEMS</p>	
	<p>Distribution Restriction Statement Approved for public release; distribution is unlimited.</p>	

ENGINEERING AND DESIGN

**Design Guidance for
Ground Water/Fuel Extraction
and Ground Water Injection Systems**

DESIGN GUIDE

DEPARTMENT OF THE ARMY
U.S. Army Corps of Engineers
Washington, DC 20314-1000

DG 1110-1-1

CEMP-R

Design Guide
No. 1110-1-1

12 November 1999

ENGINEERING AND DESIGN
DESIGN GUIDANCE FOR GROUND WATER/FUEL EXTRACTION
AND GROUND WATER INJECTION SYSTEMS

1. Purpose. This design guide (DG) provides guidance for the basic design, installation and operation of ground water extraction and ground water injection systems for the cleanup of contaminated ground water, exclusive of any treatment systems. General guidance on ground water extraction (GWE) already exists (see references below). The intent of this DG is to document lessons learned from experience and to provide a systematic approach to the installation, operation and trouble-shooting of systems. In addition, this DG identifies aspects of ground water/fuel extraction and ground water injection systems that have led to poor performance and provides solutions to these problems. The DG provides trouble-shooting charts that list problems, causes, solutions and preventative measures. The DG then provides a series of checklists for the user to follow during the implementation of a project. The checklists identify information and data needs that, when addressed, greatly improve the likelihood for project goals to be achieved.

2. Applicability. This DG applies to all HQUSACE elements, major subordinate commands (MSC), districts, laboratories, and field operating activities (FOA) responsible for HTRW remediation projects. The engineering and design procedures are applicable to all Corps of Engineers projects. If required, ground water cleanup is conducted at both Federal and commercial sites, including Department of Defense installations. This DG was written for single and multi-well systems related to the cleanup of ground water and light non-aqueous phase liquids (LNAPLs).

3. References. References are provided in Appendix A.

4. Distribution Statement. Approved for public release, distribution is unlimited.

DG 1110-1-1
12 Nov 99

5. Explanation of Abbreviations and Terms. Abbreviations and acronyms used in this DG are contained in Appendix C.

FOR THE COMMANDER:

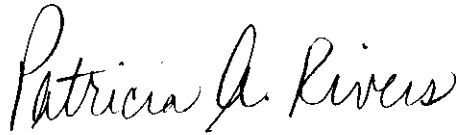

3 Appendices
(See Table of Contents)

**PATRICIA A. RIVERS, P.E.
CHIEF, ENVIRONMENTAL DIVISION
MILITARY PROGRAMS**

CEMP-R

Design Guide
No. 1110-1-1

12 November 1999

Engineering and Design
DESIGN GUIDANCE FOR GROUND WATER/FUEL EXTRACTION
AND GROUND WATER INJECTION SYSTEMS

Table of Contents

Subject	Paragraph	Page
CHAPTER 1 - GENERAL CHARACTERISTICS OF A GROUNDWATER/FUEL EXTRACTION AND GROUND WATER INJECTION PROJECT	1.0	1-2
Introduction	1.1	1-2
Extraction and Injection System	1.2	1-2
Project Phases	1.3	1-4
Remedial Investigation/Feasibility Study Phase	1.3.1	1-4
Design Phase	1.3.2	1-6
Construction Phase Design Interaction	1.3.3	1-6
Startup Phase	1.3.4	1-7
Operation/Maintenance Phase	1.3.5	1-8
Legal and Regulatory Considerations	1.4	1-8
Regulatory Agency Interaction	1.4.1	1-9
System Permitting Requirements	1.4.2	1-10
CHAPTER 2 - PROBLEMS ASSOCIATED WITH GROUND WATER EXTRACTION AND INJECTION SYSTEMS LEADING TO POOR PERFORMANCE OR UNACCEPTABLE RESULTS	2.0	2-1
Problems, Causes, and Solutions	2.1	2-1
Extraction Unit	2.1.1	2-1
Transport Unit	2.1.2	2-12
Injection Unit	2.1.3	2-13

TABLE OF CONTENTS, Continued

Subject	Paragraph	Page
CHAPTER 3 - PLANNING FOR GROUND WATER/FUEL		
EXTRACTION AND GROUND WATER INJECTION SYSTEM	3.0	3-1
Remedial Investigation/Feasibility Study	3.1	3-1
Site Conditions	3.1.1	3-1
Contamination Sources and Type Characterization	3.1.2	3-3
Hydrogeology/Soil Characterization	3.1.3	3-3
Ground Water Characterization	3.1.4	3-7
LNAPL Characterization	3.1.5	3-13
Regulatory Issues/Permits	3.1.6	3-16
Feasibility Study	3.1.7	3-16
Design	3.2	3-25
Design of Extraction/Injection Units	3.2.1	3-25
Pump Design	3.2.2	3-34
Piping Design	3.2.3	3-37
Treatment Unit Design	3.2.4	3-40
Electrical/Control Specifications	3.2.5	3-42
Construction	3.3	3-43
Preconstruction Review	3.3.1	3-43
Construction	3.3.2	3-46
Post Construction	3.3.3	3-50
Startup/Baseline Performance	3.4	3-51
Subsurface Components	3.4.1	3-51
Pumps	3.4.2	3-52
Systems	3.4.3	3-53
Baseline Measurements	3.4.4	3-53
Operating Performance	3.5	3-54
Chemical Characteristics	3.5.1	3-55
Physical Characteristics	3.5.2	3-55
Biological Characteristics	3.5.3	3-58
Maintenance	3.5.4	3-59

LIST OF APPENDICES

Subject	Appendix	Page
References	A	A-1
Remedial Investigation/Design Basis Checklist	B	B-1
List of Acronyms	C	C-1

TABLE OF CONTENTS, Continued

LIST OF TABLES

Subject	Table	Page
Ground Water Extraction/Transport/Injection System Problems and Possible Causes	2-1	2-19
Extraction Unit Troubleshooting	2-2	2-21
Transport Unit Troubleshooting	2-3	2-24
Injection Unit Troubleshooting	2-4	2-25
Analytical Methods for Cation-Anion Balance	3-1	3-10
Interpretation of Chemical Water Analyses and Analytical Methods	3-2	3-11
Considerations for System Design	3-3	3-62

LIST OF FIGURES

Subject	Figure	Page
Ground Water Extraction, Treatment, and Injection System (Typical Layout)	1-1	1-3
Injection Well Cross Section	2-1	2-16
Troubleshooting Flow Chart - Low Initial Water Extraction Rate	2-2	2-27
Troubleshooting Flow Chart - Water Extraction Rate Declining Over Time	2-3	2-30
Troubleshooting Flow Chart - Extraction Unit - Low LNAPL Removal Rates	2-4	2-32
Troubleshooting Flow Chart - Extraction System/ Inadequate Plume Capture	2-5	2-34
Transport Unit Troubleshooting	2-6	2-35
Injection Unit Troubleshooting - Low Initial Injection Rates	2-7	2-38
Troubleshooting Flow Chart - Injection Rate Declining Over Time	2-8	2-41
Injection Unit Troubleshooting - Injection Pushing Plume in Wrong Direction	2-9	2-43
Injection Unit Troubleshooting - Mounding/Flooding ...	2-10	2-44
Ground Water Extraction, Treatment, and Injection System (Sample Location Diagram)	3-1	3-39

DESIGN GUIDANCE FOR GROUND WATER/FUEL EXTRACTION
AND GROUND WATER INJECTION SYSTEMS

Purpose. This design guide (DG) provides guidance for the basic design, installation and operation of ground water extraction and ground water injection systems for the cleanup of contaminated ground water, exclusive of any treatment systems. General guidance on ground water extraction (GWE) already exists (see references below). The intent of this DG is to document lessons learned from experience and to provide a systematic approach to the installation, operation and trouble-shooting of systems. In addition, this DG identifies aspects of ground water/fuel extraction and ground water injection systems that have led to poor performance and provides solutions to these problems. The DG provides trouble-shooting charts that list problems, causes, solutions and preventative measures. The DG then provides a series of checklists for the user to follow during the implementation of a project. The checklists identify information and data needs that, when addressed, greatly improve the likelihood for project goals to be achieved.

Applicability. This DG applies to all HQUSACE elements, major subordinate commands (MSC), districts, laboratories, and field operating activities (FOA) responsible for HTRW remediation projects. The engineering and design procedures are applicable to all Corps of Engineers projects. If required, ground water cleanup is conducted at both Federal and commercial sites, including Department of Defense installations. This DG was written for single and multi-well systems related to the cleanup of ground water and light non-aqueous phase liquids (LNAPLs).

References. This DG should be used in conjunction with the following USACE suggested design guidance documents (EM 200-1-2, EM 200-1-3, EM 1110-1-4000, ER 385-1-92, ER 1110-1-263, ER 1110-345-720, ER 1110-345-10028, ER 1165-2-13226, OM 25-1-51, TM 5-813-1). Required and related publications are listed in Appendix A.

Discussion. Appendix B represents the procedures and considerations associated with the design and trouble-shooting of ground water extraction and injection systems. It contains checklists and flow charts to be used investigation, characterization, design, and operation of a ground water cleanup project. Appendix C provides a list of acronyms throughout this DG.

Action. Each U.S. Army Corps of Engineers design element will be responsible for incorporating guidance into HTRW or military construction designs. This DG will be considered as the design guidance for ground water extraction units, exclusive of any treatment systems.

Implementation. This information is furnished to assist designers and operators in avoiding past problems in design and operation of new and/or retrofitted facilities used to extract, convey and inject treated water into the ground. Information presented herein is in addition to USACE EM 1110-1-4000, Monitoring Well Design, Installation, and Documentation at HTRW Sites. Use of the DG is not limited to HTRW, Civil Works or Military Construction.

1.0 GENERAL CHARACTERISTICS OF A GROUND WATER/FUEL EXTRACTION AND GROUND WATER INJECTION PROJECT

The purpose of this chapter is to familiarize the reader with the elements common to most extraction and injection projects.

1.1 Introduction This chapter describes the components and phases of a typical ground water and fuel extraction and ground water injection project. This chapter also defines regulatory considerations, personnel and skills needed to undertake such a project. A common system configuration is illustrated and explained.

1.2 Extraction and Injection System A typical ground water extraction, treatment and injection system is designed to function as an integrated unit in which the proper operation of one component is dependent on the proper operation of the other components. While the system may function if some of the extraction or injection wells malfunction, performance goals may not be achieved.

The extraction, transport, treatment and injection system is considered a single unit. However, for the purpose of this DG, the system is subdivided into major components. Those components are the extraction unit, the transport unit, the treatment unit (not covered in this DG), and the injection unit. Figure 1 illustrates a typical system.

The extraction unit includes wells, well fields or trenches to remove contaminated ground water or light non-aqueous phase liquids (LNAPLs). The extraction unit includes pumps or other mechanisms used to bring fluids to the surface.

The transport unit includes piping from the extraction unit to the treatment unit, piping within the treatment unit, and piping to the injection unit.

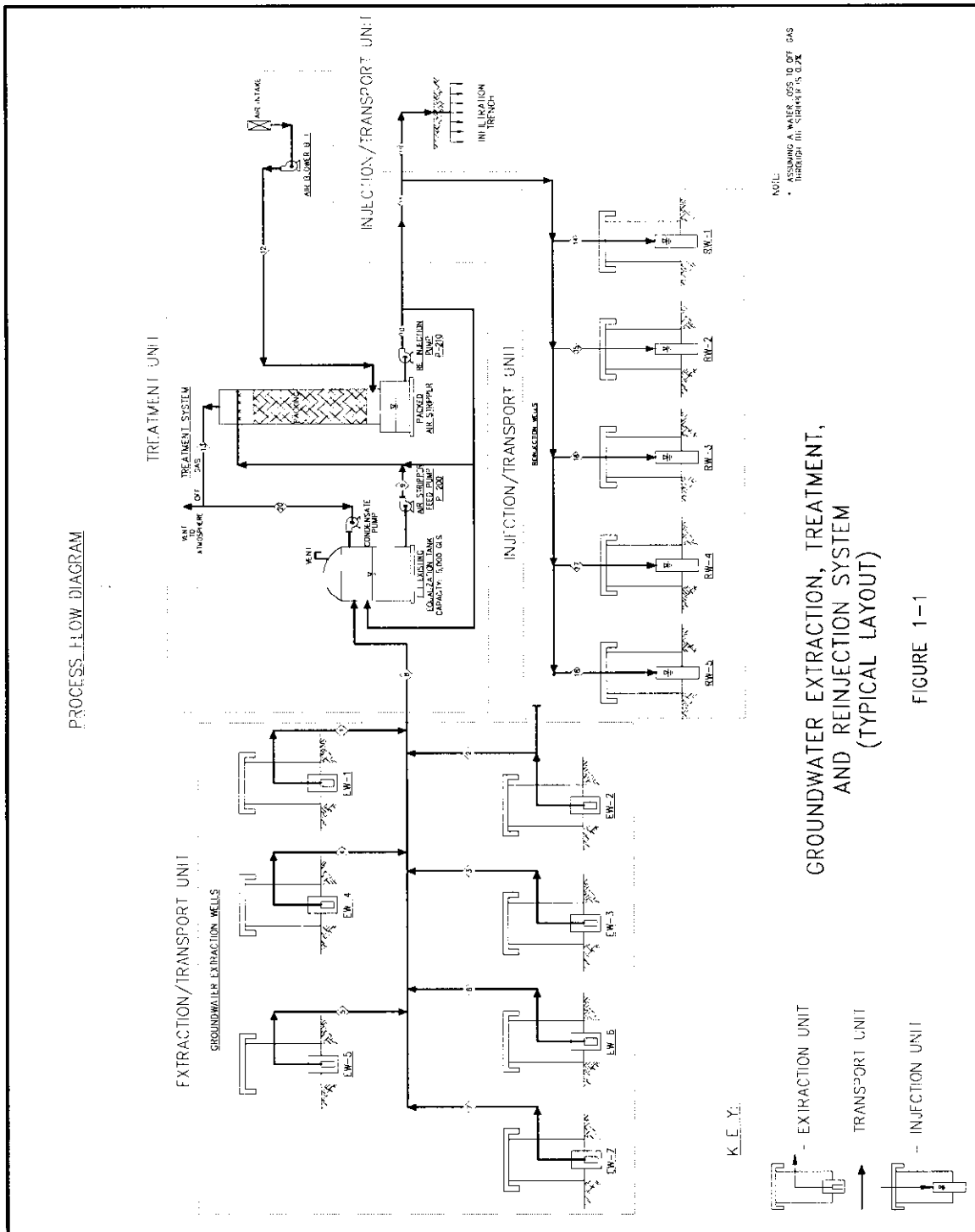

Key issues to consider when selecting, designing and operating the transport unit include pipe sizing, pipe material compatibility and climatic considerations such as freeze protection and expansion allowances. Pipe issues are covered in EM 1110-1-4008.

The treatment unit is used to reduce contaminant concentrations to levels which are acceptable for disposal or injection. Discussion of treatment technologies is beyond the scope of this DG.

The injection unit, like the extraction unit, can include wells or trenches to dispose of treated ground water, to accelerate cleanup through enhanced flushing of the saturated zone, and to create hydraulic barriers to prevent further migration of contaminant plumes. The water is injected either by gravity feed or under pressure. Because of the injection role in influencing the direction of ground water movement, the proper location of injection points is critical.

1.3 Project Phases Ground water remediation projects generally begin with a preliminary site investigation to determine the presence of known or suspected contamination. Once contamination is confirmed to exceed acceptable levels, a ground water remediation project may be implemented. Ground water remediation projects can be subdivided into phases, each of which has clear goals, a schedule and specific activities. For the purposes of this DG, ground water remediation projects are subdivided into the following five phases:

- Remedial Investigation/Feasibility Study
- Design
- Construction
- Startup
- Operation/Maintenance

1.3.1 Remedial Investigation/Feasibility Study Phase The term Remedial Investigation (RI) is used by the USEPA to describe investigations at Comprehensive Environmental Response Compensation and Liability Act (CERCLA) sites. The comparable term used by the USEPA for Resource Conservation Recovery Act (RCRA) sites is a RCRA Facility Investigation (RFI). Objectives of the RI/FS are as follows:

- estimate the types and extent (present and future) of dissolved ground water contamination;
- estimate the volume and extent (present and future) of LNAPL (if any);

- collect sufficient physical and chemical measurements of geologic materials to allow choice of appropriate remedial technologies.

The RI is used to define the nature and extent of the problem, support risk assessment to define remedial goals and provide a baseline of information to allow comparison of remedial alternatives. Key RI and RFI guidance documents are as follows (Refer to Appendix A, References, Section A-1.c for full citation.) USEPA (OSWER Directive 9355.3-01), 1988, USEPA 540/G-87/004 (OSWER Directive 9355.0-7B), 1987, and USEPA 530/SW-89/031 (NTIS#PB89-200299), (OSWER Directive 9502.00-6D), 1989.

The term Feasibility Study (FS) is used by the USEPA to describe comparison of remedial alternatives for CERCLA sites. The comparable term used by the USEPA for RCRA sites is a Corrective Measures Study (CMS). Objectives of the FS are as follows:

- define cleanup goals, points of compliance and performance criteria for remedial systems; and
- develop a list of applicable alternatives;
- compare, choose and conceptually specify the most appropriate combination of extraction transport, treatment and injection (if applicable) techniques.
- prepare a list of data, based on selected remedial technology, to be obtained during the FS or design phase for detailed design.
- Frequently models, pump tests and treatability studies are run to confirm the practicality or technical feasibility of the remedial alternatives.

Gathering the appropriate information in a timely manner is critical. The Remedial Investigation/Feasibility Study checklist in Appendix B provides a detailed list of the typical data requirements to allow evaluation of alternative remedial options and design a ground water remediation system. Additional discussion of this checklist is provided in Section 3.2.

Key FS and CMS guidance documents are as follows (refer to Appendix A, References, Section A-2.a for full citation):

(USEPA OSWER Directive 9355.3-01, 1988, USEPA 540/R-92-071a, 1992, Driscoll, 1986, USEPA OSWER Directive 9355.4-03, 1989, USACE ER 1165-2-132, USACE EM 200-1-3, USACE EM 1110-1-4000, and USACE EM 1110-1-502).

1.3.2 Design Phase The design phase converts conceptual specifications developed during the FS into construction plans, specifications and design analysis. This phase may require some follow-up data collection. While preliminary construction cost estimates are generated during the FS for purposes of comparison, the design phase provides the detailed pre-bid construction estimate. If the detailed cost estimate is greater than the allowable budget, then design modifications may be initiated to develop a design that is within budgetary constraints. The designer may recognize the need for supplemental information in order to modify the design to allow lower construction or operating costs. Thus, as previously discussed, the process becomes interactive. However, unlike RI/FS investigations, the designer is now in a better position to estimate the benefit and predict the sensitivity of the final design to gathering additional data. This cost/benefit approach should be considered prior to requesting or undertaking activities to gather additional data.

During the design phase it is also frequently found that site specific testing allows replacement of conservative assumptions with real data, resulting in a less conservative (less costly) design. For example, performance of an extended pumping test on a pilot extraction well can allow specification of a narrower range of potential pumping rates and frequently results in specifications of lower influent concentrations than those based on estimates from monitoring wells. Additional detail on design analysis and specifications can be found in USACE ER 1110-345-700.

A design phase checklist is provided in Appendix B. A detailed discussion of the checklist is presented in Section 3.2.

1.3.3 Construction Phase Design Interaction It is crucial to understand that the RI, FS and design phases are interactive. During the FS it is frequently found that additional measurements (e.g. cation/anion analyses) are required to finalize comparison of remedial alternatives. Many design teams have found that during (in) the design and installation phase, and before installing the full scale system, installing a limited number of wells can effectively provide information that would verify that the original design basis for the system is appropriate.

A qualified geologist/geotechnical engineer should provide continuous supervision during construction/installation/development to ensure proper completion of the system. The oversight geologist/engineer should have experience in the installation of well and trench systems. Ideally, the person should have also been involved in the design phase. This person will assist in documenting changes made during the construction phase. This requires effective interpretation of the designer's plans and specifications by the builder. Attention to details

and documentation during the construction phase will result in the installation of the system in a safe and efficient manner. A construction phase checklist is provided in Appendix B. Additional details regarding the construction phase are discussed in Section 3.4.

Some ground water extraction and injection systems are sensitive to the method of construction. The on-site geologist/geotechnical engineer should discuss with the design engineer and project hydrogeologist those aspects of the design which have the potential to cause problems if variations occur during construction. The construction drawings are required to be marked with any changes during the construction and be revised for submittal as "as-built" drawings.

1.3.4 Startup Phase The design phase includes issuance of a preliminary operations and maintenance (O&M) plan which specifies schedules for mechanical maintenance, inspections, recording of data, monitoring of ground water and monitoring of influent and effluent quality. However, actual system performance and details of day-to-day mechanical issues requiring site specific procedures are not accurately known until start-up has occurred.

Therefore, the preliminary O&M plan typically includes a startup plan for intensive evaluation, monitoring and adjustment for a period which can range from weeks to months. Objectives of the startup phase are as follows:

- verify that mechanical systems and controls are operating as per design criteria;
- verify design assumptions;
- measure the actual water balance, capture zones and treatment efficiencies;
- identify design flaws (if any);
- identify unforeseen operational or hydrogeologic issues which may require adjustments to design or operating procedures; and
- develop detailed O&M protocols for maintenance, mechanical operation, monitoring and adjustment of controls to optimize performance.

During the design and construction process, certain operating parameters (design analysis specifications) are proposed to measure performance. If well systems are installed and pilot tested prior to treatment system installation, the information gathered about actual well production and concentrations can be used to modify design as necessary.

Operational parameters can also be verified during the startup phase. Ideally, scientists and engineers originally involved in the design should observe the start-up of the extraction/transport/ injection systems and assist documenting the operation of each system. The team performs shakedown (startup and shutdown) of each system and records operating conditions. This process results in a punch-list of recommendations for modification/ changes to optimize operation. After the shakedown period and after making any modifications/changes to the system, the system is brought into continuous operation. Documentation of all activities and modifications during the startup phase is important to ensure that as-built diagrams and final O&M procedures are updated to reflect adjustment.

A startup phase checklist is provided in Appendix B. Additional discussion of this checklist is contained in Section 3.5.

1.3.5 Operation/Maintenance Phase Operation and maintenance are the continuing activities that are required to achieve successful completion of the project. The two primary objectives of this phase are to monitor system performance (extraction/injection/treatment systems) and to perform routine maintenance in a manner which optimizes operation. Consistent monitoring of system performance and adherence to maintenance schedules is critical. O&M plans should be created by the designer of the well system and supplied to the operator. Plans should begin at the installation of the system and maintained throughout. If data are inconsistently gathered or interpreted, it may be erroneously concluded that there has been a systems failure. Likewise, irregular maintenance can result in poor performance and equipment breakdown.

The key to successful operation of a system is regular evaluation of operating and monitoring data by the on-site operator and the technical team (engineers and hydrogeologists). The O&M plan specifies a regular schedule for communication between the operator and the technical team in which the operator is provided with updated priorities for optimization (e.g. wells at which to maximize pumpage) and in which the technical team is provided with observations regarding mechanical performance. The O&M plan must clearly establish responsibilities and the chain of authorization for changes to the system.

The operation and maintenance checklist to support this activity is provided in Appendix B. A detailed discussion of the checklist is presented in Section 3.6.

1.4 Legal and Regulatory Considerations The designer of a ground water remediation system must be aware of applicable laws and regulations or have the resources available to obtain

information on regulations. Most ground water remediation projects are implemented under regulatory programs pursuant to laws such as CERCLA, RCRA, or similar state programs. A project may be initiated by a lead agency acting under an authorized response program, or a private entity responding to an enforcement action, providing compliance with a permit requirement, or performing a voluntary cleanup. The following paragraphs discuss possible strategies to be used when interfacing with regulating agencies and also highlight some differences between regulatory programs that can affect remedial strategies.

It is a legal question to determine if the Federal agency leading the site cleanup (e.g. USACE) is subject to any laws or regulations which would govern private activities. As a general matter, the doctrine of sovereign immunity prevents Federal or state regulators from applying any law or regulations to Federal agencies in the absence of a clear and specific waiver. Many environmental laws contain some waiver of sovereign immunity, but determining the applicability to particular programs and projects and situations is a matter which must be decided by counsel for the lead agency. There are differences if the work is conducted under the Superfund program for USEPA, the DERP IRP, DERP FUDS, non-DOD Federal agencies or the USACE civil works program. In addition, contractors do not have the immunity of a Federal agency. As a matter of comity, Federal and state substantive standards should always be considered in the design and execution of projects.

1.4.1 Regulatory Agency Interaction The remedial action may be subject to oversight by a Federal or state regulatory agency, usually with the lead agency conducting the work. The site owner/operator may want to be proactive in managing and implementing the project so that cost-effective solutions are proposed to the regulatory agency for their concurrence. The proactive approach is often the better method for managing remediation projects.

Some of the ways to coordinate effectively with regulators are:

- clearly define which agency has responsibility for and authority over the project;
- assign a knowledgeable project manager and regulatory team member;
- consider agency interaction as an integral part of the technical project planning process;

- actively solicit the regulators' comments so that they are part of the project team and avoid taking unnecessary adversarial positions with the regulators;
- communicate frequently and openly with the regulators regarding factual data to maintain good relations and to ensure that all parties are informed of the work plans, schedules, and progress for the remediation effort;
- notify the regulatory agency early regarding problems or issues with the remedial action and propose solutions to obtain their concurrence after internal coordination is completed and an agency position has been established;
- set realistic schedules for project milestones and consistently meet the schedules;
- work directly with the designated agency point of contact when coordination with several regulatory offices is required;
- after consulting with agency counsel, if appropriate, provide suggestions on interpreting regulations, especially those areas where regulators have discretion under the rules;
- prepare legal reports identifying legal regulatory standards, indicating the steps taken to address them, and providing concise summaries of conclusions; and
- provide project status reports (i.e., weekly, monthly, quarterly, etc.) to the regulatory agency and other involved parties informing them of accomplishments, schedule updates, and problems, if any. Consult agency counsel on questions about releases of privileged or confidential information.

These activities should only occur after internal staff of the lead agency, including counsel, have established the agency's position. It is essential to have good lines of communications between all parties involved in the project. The key is to avoid surprises and head off problems before they arise.

1.4.2 System Permitting Requirements The following subsections summarize permitting considerations associated with construction of ground water extraction and injection systems. Consult counsel and lead agency to determine if a permit is actually required, but always consider the substantive standards in deciding on the work to be done.

1.4.2.1 Extraction Unit Permitting and other procedural requirements potentially applicable to the installation of ground water extraction units may include the following:

- permits to construct extraction wells;
- permits to extract ground water (for large extraction units in some states with limited ground water resources);
- access agreements for off-site wells; and
- submittal of well abandonment records when the system is shut down;
- proper license held by well installation contractor.

The process for obtaining an extraction well permit usually includes submittal of an application specifying a design which meets the standards of the state rules. This is followed by receipt of a permit from the regulatory agency. Although not a permitting requirement, most states require that all utility companies be contacted several days before drilling to ensure that underground lines are located and avoided. States may seek to require that work be performed by a licensed driller and that "as-built" logs be submitted to the state following installation. Federal employees are not required to be licensed by the state as long as they meet qualification standards of the employing agency.

Several western states have ground water use laws which require a permit to extract ground water under certain circumstances. Permitting requirements vary widely but may include specification of maximum withdrawal rates, estimation of impact on existing well fields and fees associated with consumptive use of ground water.

Prior to agreeing to any asserted permitting or fee payments, counsel for the lead agency should determine what permit requirements, if any, apply to the project.

Authorization for access will be required prior to installation of wells on property not under the control of the land owner. In this situation, authorization from the off-site property owner should be in the form of a written access agreement. Either agency counsel or designated real estate staff will arrange for appropriate access agreements.

Shutdown of systems at the completion of remediation usually includes abandonment of wells in accordance with state rules. After performing abandonment (which may entail well removal, grouting or well capping), an abandonment record is typically submitted to the state by the licensed driller who performed the operation, after approval by the lead agency. The proper abandonment of wells and exploration borings needs to be

documented and the abandonment completed as soon as it is determined that the well is no longer needed.

1.4.2.2 Transport Unit The ground water transport unit may include extraction pumps, piping, valves, surge tanks, transfer pumps, and injection pumps and piping. RCRA requires frequent inspections of above ground piping for leaks and a double-walled leak detection system for underground piping that transports hazardous waste. Fuels and oils are not classified as RCRA hazardous wastes and are generally exempt from these requirements. The requirements for the design and operation of those units that will manage listed or characteristic hazardous waste are detailed in 40 CFR 264. These rules outline the design, operating and inspection requirements for tanks, piping, controls, and containment systems.

1.4.2.3 Injection Unit Underground injection requirements are governed by the Federal Underground Injection Control program (UIC), which may delegate responsibility for the program to states. An individual state's UIC program generally regulates underground injection of water by permitting and monitoring. Permits may place limits on the quantity and quality of water to be discharged and specify methods to be used to design systems. Contamination limits may be based on the Maximum Contaminant Levels (MCLs) established under the Safe Drinking Water Act, depending on site specific circumstances. Cleanup criteria for treated water may be specified in a Record of Decision under CERCLA, a RCRA Corrective Action Plan, an administrative agreement or other decision document issued or agreed to by the lead agency.

During operation of injection wells, a permittee must implement monitoring and record keeping requirements that are specified in the permit.

2.0 PROBLEMS ASSOCIATED WITH GROUND WATER EXTRACTION AND INJECTION SYSTEMS LEADING TO POOR PERFORMANCE OR UNACCEPTABLE RESULTS This chapter provides "trouble-shooting" tools to diagnose and find solutions for extraction, transport and injection units which are performing poorly. This Chapter provides tables which list problems, causes and solutions.

Many ground water extraction and injection system problems are due to oversights and errors in the RI/FS or design phases of the project. The identification and avoidance of serious design flaws is presented and discussed in Chapter 3.

2.1 Problems, Causes, and Solutions Problems with new and existing systems are identified by comparing system performance to the original system design analysis that describes what the system was intended to do and the initial system startup (baseline) data that indicate what the system was capable of doing when it first began operation.

Table 2-1 (located at the end of Chapter 2) identifies the primary symptoms/problems that have been observed with extraction, transport and injection units. Tables 2-2, 2-3, and 2-4 (located at the end of Chapter 2) are detailed trouble-shooting tables for extraction, transport, and injection units, respectively. The trouble-shooting process for extraction, transport and injection systems are illustrated, as Flowcharts, in Figures 2-2 through 2-10, also located at the end of Chapter 2. Note, "symptom" has not been defined as a specific system component failure, but rather as failure of the system to achieve an established objective. This approach allows the identification and consideration of more problems than the specific mechanical issues with which a system operator may be most familiar. The following sections expand on the topics presented in Table 2-1.

2.1.1 Extraction Unit The extraction unit can include extraction wells or trenches for the recovery of contaminated water and/or LNAPL. Table 2-2 is an extraction unit trouble-shooting chart, which describes the common symptoms, problems, problem descriptions, and solutions. References which provide detailed guidance are: Driscoll, 1986, USEPA OSWER Directive 9355.4-03, 1989, Helweg et al., 1983, Smith, 1995, U.S. Department of the Interior, Ground Water Manual, 1981, USEPA 600/R-94/123, 1994, Wisconsin Dept. of Natural Resources, PUBL-SW183-93, 1993, USEPA 510/R-96/001, 1996.

2.1.1.1 Low Water Production Rate A low water production rate is normally identified by comparison of actual production measurements to an expected rate that was established by pumping tests, modeling or during startup. Newly installed wells/trenches should be able to achieve the design analysis pumping rate at the time of commissioning.

Specific problems that may cause low initial water production rates are:

1) **Incomplete Characterization** of the site hydrogeology which may have resulted in inaccurate modeling of recovery systems during the design phase. Water production rate estimates are normally field verified by aquifer pumping tests which are performed prior to the design phase of the project. If modeling does not closely correlate with actual field aquifer pumping tests, the models should be reevaluated before any additional use.

For an existing extraction unit whose performance does not meet project objectives, evaluating the site characterization database using the checklist approach described in Chapter 3 may assist in identifying the required information that was not obtained during the design.

2) **Inappropriate Well Design Elements** which could result in inadequate production rates if improperly specified include: borehole diameter, filter pack sizing, well screen slot size, well screen material (e.g., stainless steel vs PVC), well screen area, well screen geometry and the location and length of the screened interval.

It is often difficult to effect performance of a poorly designed well by manipulating external factors such as pumps and level controllers. Therefore, solving an existing deficient well design frequently requires well replacement after determining the likely cause of well failure. Refer to Water Supply Sources and General Considerations (TM 5-813-1), U.S. Army Technical Manual, for information regarding water supply sources.

3) **Insufficient Well Development** may result in initial well production rates that are lower than the wells true capacity. This may be the result of ineffective or incomplete removal of drilling residue from the filter pack and the adjacent formation. This condition can be identified by confirming the presence of excessively turbid or high specific conductance in water, drilling fluid residues, or formation materials in the well.

Time limits should be established to ensure that mud rotary wells are not allowed to remain undeveloped for excessive lengths of time. Predevelopment takes place just after the filter pack is added to the annular space around the screen. The objective of predevelopment is to remove drilling fluids and natural fines which are still mobile and can settle the filter pack against the screen. Fines are much more easily removed at this time, which saves development time after full well completion. This will allow the filter pack to settle, thus allowing the additions of more filter pack before the bentonite seal is installed. Where

possible, wells should be predeveloped by removing as much of the drilling fluids and muds during well installation. Failure to start development within reasonable time may cause problems with subsequent development, such as the need for more vigorous development procedures to remove drilling fluids and set the filter pack. In some cases, the well may not respond to development procedures and may result in the loss of the well. Subsequently, it may be necessary to properly redevelop the well with a procedure that will address the particular problems identified in the well. Poor development is a major contributing factor to biofouling problems in extraction and injection wells.

4) **Improper Pump Size** may result in low water production rates. This is often caused by inaccurately estimating the discharge head required to raise water from the well and push it through piping to the treatment unit. Under certain conditions, pumps capable of flow rates much greater than the discharge head requirement can also result in low well production rates due to excessive cycling, and their inability to develop and maintain a steady drawdown condition. In addition, oversized pumps cause mixing in the well and sometimes emulsification of LNAPL.

Pump size also plays an important role in mechanical reliability of equipment. Inadequate space between the pump and the well casing does not allow proper cooling of the pump motor and results in overheating and damage. The physical configuration of a pump must also be considered. As an example, an 18.4 cm (73 inch) outside diameter pump may fit inside a 20.3 cm (8 inch) inside diameter well and also meet discharge pressure requirements. However, the pump wiring is likely to be damaged during periodic maintenance removal and reinstallation due to abrasion with the well casing. Two ways to avoid pump wire damage is to ensure that pump wiring is affixed to the drop pipe of the well as pumps are installed into wells, and to ensure that there is sufficient annular space.

In order to prevent this problem specify the proper design parameters to select pumps that are capable of delivering the desired discharge head, provide flexibility in the range of flow rate control, and have adequate space for keeping the motor cool for better performance.

5) **Physical Damage/Blockage** to the well screen, pump inlet, or pump discharge piping may result in low water production rates. Pump problems are usually caused by careless installation and can be corrected by removing the pump from the well, inspecting the assembly for damage, and repairing as appropriate. Damage to the well screen is usually accompanied by the intrusion of filter pack and formation material into the well casing and is more difficult to repair. Generally the solution to well screen damage is the installation of a new well.

6) **Seasonal Aquifer Water Level Variation and Usage** may result in changes in production rates during periods of low precipitation.

7) **Incorrect Pump Control and Intake Settings** can result in lower than expected production rates if the low level control device (pressure switch, electrode or amperage meter) or pump intake is set at a shallow depth or low measurement threshold which shuts off the pump before the full available drawdown of the well has been achieved. This problem is detected by measuring well draw down at the pump shut off point and comparing it to the design expectation. This problem is rectified by lowering the pump intake to a greater depth or adjusting the low level control device to allow greater drawdown.

8) **Improper Construction** can affect water production rates. Contractor substitutions during construction can affect dynamics of the system and flow rates. Substitutions such as a slight reduction in pipe diameter or use of different fittings than those specified can affect system performance. All important system components should be installed exactly as shown and specified. Changes in system components should require a submittal to the design engineer.

2.1.1.2 Decrease in Production Rate Over Time A decrease in water production rates from extraction units may be observed over time by comparing current individual well production rates to baseline and previous performance records. Another useful measure of well productivity is specific capacity (gpm per foot of drawdown). This parameter should be measured during the baseline period and periodically during the operating period. Specific capacity or other performance criteria should be evaluated regularly and consistently. Specific guidelines should be written into the O&M plan to require notification to the lead agency that approved maintenance will be carried out. Production rate declines or decreases in specific capacity may be the result of the following problems:

1) **Mineral Encrustation** of well screens, pumps, impellers, level controllers, and piping is a common problem. Mineral encrustation problems can be addressed through a combination of preventative measures, routine inspection and maintenance. Encrustation consists of minerals which form with pressure drops, carbon dioxide off-gassing, aeration or other geochemical changes caused by pumpage, and shift equilibrium solubilities within the well/pump/piping system. This problem manifests itself as deposits that block well screen and pump inlets, plug discharge piping, and prevent the normal operation of level controllers. As the encrustation builds, production rates of wells drop off steadily. Trench extraction units are usually less sensitive to mineral encrustation because the pressure drop between the

formation and the inside of the sump is less severe, resulting in less carbonate formation.

Typical encrustation compounds include calcium and magnesium carbonates or sulfates, iron oxides, iron or magnesium hydroxides and sulfate salts which can vary from hard, brittle deposits to sludges or gelatinous materials. The solution to mineral encrustation problems is a combination of preventative measures and routine inspection and maintenance. The system should be designed to be as tolerant of scale buildup as possible by selecting durable well construction materials such as wire-wrapped, stainless steel well screen, pumps that do not have scale-sensitive moving parts or level controls, and equipment that can be easily removed and disassembled for cleaning. Also setting the intake of the pump above the screen minimizes the oxidation of iron and thus reduces biofouling of the screened area.

From a maintenance perspective, developing an effective well chemical treatment program based upon the system-specific water chemistry is critical. This program can be on a periodic schedule based on the rate of mineral build-up or a continuous-feed treatment system. Once the treatment process is established, routine treatment of wells followed by performance monitoring will identify any adjustments that may be required to optimize the treatment effectiveness. As part of maintenance, a chemical treatment program based on site-specific water chemistry may be necessary. Differences in water chemistry may be necessary. Differences in water chemistry between extracted (untreated) and treated water, as well as differences in water chemistry between individual wells may have to be taken into account to properly implement a chemical treatment program. Driscoll (1986) and Smith (1995) provide detailed guidance.

2) **Biological Fouling** results from the proliferation of microorganisms in the formation, filter pack or well screen. This proliferation is usually caused by the introduction of oxygen into the well (e.g. through over pumpage which drops the water level below the top of screen). However, fouling can also be caused by anaerobic bacteria metabolizing organic compounds. Biological fouling can be caused directly by the buildup of biomass or indirectly by the buildup of minerals formed as a byproduct of biological processes. Biologically facilitated mineral encrustation can include oxidation of iron, manganese and sulfur compounds. Hydrogen sulfide/sulfate reducing bacteria can promote corrosion of some well screens.

Generally, if the conditions are favorable, biological fouling is unavoidable. After a film of aerobic, bacterial growth has coated the inside of a well or pipe, anaerobic conditions may develop under the film. Anaerobic conditions under the film may then lead to accelerated corrosion of the

wells and piping. Sulfate reducing bacteria are one group of anaerobic bacteria that can promote corrosion. However, preventative treatments can minimize fouling and systems can be designed to include materials that are resistant to treatment chemicals and include equipment that will function reliably with some degree of fouling. Regular, preventative well disinfection and prevention of overpumpage (which can aerate the formation) may delay the onset of biological fouling. Biological fouling which originates within a well can spread outward into the formation if preventative treatment is not performed. Once fouling has spread into the formation, rehabilitation to regain desired flow rates may be difficult, expensive or impossible.

As indicated above, mineral encrustation and biological fouling may occur simultaneously. Therefore, several treatment steps may be required. Biological treatments commonly include a step to eliminate microorganisms (e.g. application of a bactericide or bleach) followed by a step to break up and remove biomass and mineral encrustation (e.g. application of an organic acid). A sequestering agent and wetting agent may be used to help remove biomass and precipitants. In cases of severe fouling, several iterations of these two steps are frequently required to rehabilitate the well. Treatment chemicals should be carefully evaluated to verify that they do not contain compounds which could act as nutrients or facilitate further mineral formation if left behind at residual levels following treatment (e.g. nitrates or sulfates). Driscoll (1986) and Smith (1995) provide extensive guidance for prevention and treatment.

3) **Siltation** is the accumulation of excessive formation clays, silts and fine sands in wells or trench sumps. Siltation may be the result of inappropriately sized filter pack or well screen. Other possible causes of siltation include screen damage, improperly installed well joints, or improper development. Potential problems caused by siltation are reduced available screen capacity, plugging of pumps/piping, and excessive wear of pump impellers. Minor accumulation of silt is normal in a properly installed and developed well.

The most direct solution to siltation is to remove as much of the accumulated material as possible and redevelop the well. If siltation continues, a downhole camera should be used to identify damage to the screen and/or pipe joints, and document existing well conditions prior to beginning rehabilitation. If the well screen is damaged, other mechanisms may be required to reduce siltation. This may include insertion of a smaller diameter well screen and casing section into the damaged well. A second alternative is to raise the pump higher in the well where it will not be impacted by intruding silts. This approach may provide satisfactory results in those situations where the silt level within the well stabilizes over time.

High entrance velocity of water into the well adjacent to the pump intake is commonly the mechanism by which silt is mobilized. If there is available water column, raising the pump intake above the top of screen may reduce siltation by decreasing entrance velocities of water.

4) **Extended Periods of Dry Weather** may cause declines in water production rates from shallow water table systems due to lack of recharge. In these areas, thin saturated zones may depress to levels that do not permit cones of depression to intersect to capture all of the plume. During these periods, water levels drop, production rates decline and pump control settings may become inappropriate. In extreme droughts, water levels may fall below pump intakes or below the bottom of wells.

To avoid this problem, wells should be designed with sufficient screened interval to accommodate seasonal water level declines. In addition, O&M plans should include provisions for seasonal adjustments to the system to allow effective operation at the lower water levels. In prolonged droughts, wells may need to be deepened or replaced.

At a site having shallow water table aquifers where extraction is required, the designer should consider the use of shallow trenches, as their design addresses seasonal water fluctuations.

5) **Incompatible Pump Components** may result in decreasing production rates when chemical/physical conditions in ground water erode impellers, damage wiring insulation (resulting in short circuits) or cause leaks in air or water lines. This problem usually develops over a long period and is identified through a review of long term production rate trends and maintenance records. It is unusual to experience a dramatic system failure through incompatibility problems.

If this problem occurs, materials that are adversely impacted should be replaced with components that are compatible. If reduction in production rates is slow, routine replacement of inexpensive parts may be adequate. In order to avoid this potential problem, the designer should specify pumps designed for environmental operations. Most pump manufacturers have chemical compatibility charts to allow appropriate pump material specification.

6) **Well Interference** may result in reduced water production rates from wells spaced too close together and by seasonal water usage such as irrigation which may affect regional water levels. This may also cause excessive dewatering which reduces hydrocarbon recovery and can cause frequent cycling and damage to pumping equipment.

Ultimately this is a system design problem in that the wells may recover too much of the available water and the rates begin to drop off shortly after system startup. Solutions to this problem are to lower the pumping rates in individual wells to maintain a steady-state flow condition (particularly where hydrocarbon recovery is a concern), or to shut down recovery in alternating wells where the capture zones overlap. These solutions, however, may result in deficiencies for other system goals, such as plume capture.

2.1.1.3 Low LNAPL Removal Rates Ideally, LNAPL is independent of ground water recovery with maximization of LNAPL recovery and minimization of water removal.

Depending on site conditions, LNAPL recovery equipment may be quite different from more conventional ground water extraction equipment. In some cases both types of recovery equipment are required. In those instances, trouble-shooting low LNAPL removal rates becomes more complicated. API (1989) provides an excellent summary of LNAPL recovery methods and equipment. The following references provide detailed guidance: Abdul, A.S., 1992, Chiang, et al., 1990, Hampton and Heuvelhorst, 1990, Hayes et al., 1989, Testa and Paczkowski, 1989, Wilson and Conrad, 1984 and USEPA 510/R-96/001, 1996.

1) **Poor Site Characterization** can cause low LNAPL recovery, unsafe operating conditions and over/under estimation of recoverable LNAPL volumes.

Site characterization for design of LNAPL recovery systems must include measurement/estimation of the vertical/lateral extent of mobile LNAPL and residual LNAPL. The extent of residual LNAPL is controlled by the physical properties of LNAPL and soil, the rate of migration and seasonal water table fluctuations which smear LNAPL above and below the water table. Distinguishing between free flowing and residual LNAPL influences performance expectations, well placement, pump specifications, pumping strategies and screened intervals. Key measurements which are used to estimate LNAPL volumes and recoverable amounts include the following:

Detailed observations of soil staining in primary porosity and soil cracks/fissures during geological logging of soil samples: These qualitative observations are used to evaluate the primary pathway of LNAPL migration through soil. These findings influence assumptions made during estimation of recoverable LNAPL volumes.

Seasonal changes in LNAPL thicknesses and water levels in monitoring wells: These measurements are used to define the

appropriate screened intervals for recovery wells and depth setting for pump/skimmer intakes.

Comparison of observed depth at which soils became saturated during drilling to depth of water level in well after development: This comparison allows estimation of the location of the capillary fringe upon which LNAPL can accumulate. This estimate is integral to correction of LNAPL thickness measurements from monitoring wells. This comparison is facilitated by measurement of soil moisture content and percent saturation in soil samples from above, at and below the water table.

Comprehensive chemical analyses of ground water constituents: Analyses of volatile and semi-volatile organic compounds performed by GC/MS will initially confirm constituents present, and help to identify appropriate, less expensive, analytical methods (e.g. SW-846 Method 8021), other GC analyses, and various petroleum hydrocarbon analyses to be used during mapping of the dissolved plume, and monitoring of remedial systems.

LNAPL specific gravity (ASTM D445 & D971): LNAPL specific gravity is used to correct water levels measured from wells which also contain LNAPL.

LNAPL interfacial tension and viscosity (ASTM D-88, D-4243, D87 and D2285): These measurements are used in calculations to estimate the total recoverable volumes of LNAPL.

Soil bulk dry density (ASTM D4564) and Soil moisture control (ASTM D2974): Soil bulk dry density is used to calculate total porosity, and in combination with soil moisture measurements from above the water table, to estimate effective porosity. These porosity estimates are used to calculate total and recoverable volumes of LNAPL.

Soil sieve analyses (ASTM D422): These measurements are used to estimate capillary fringe thicknesses, LNAPL volumes and to design well screen slot sizes.

Fraction of organic carbon in unimpacted soil (Page, 1986): These measurements are used in calculations to estimate the amount of dissolved compound sorption onto aquifer materials.

LNAPL baildown tests (Gruszczenski, 1987; and Hughes et. al, 1988): These tests (approximately analogous to a slug test for ground water) provide an empirical, qualitative measure of potential LNAPL recovery rates.

Estimating true versus apparent product thickness: Methods for estimating true product thickness on the basis of: a) apparent LNAPL thickness observed in monitoring wells, and b) fluid and

porous media properties, have been developed by Lenhard and Parker et al. (1990) and Farr et al. (1990). These methods assume an equilibrium distribution of the three fluid phases (LNAPL, water and air) and require measurement (preferably) or estimation of capillary pressure-saturation curves for soils within the capillary fringe where most of the LNAPL typically resides. Due to spatial variability in subsurface properties, water table fluctuations, and other uncertainties, these methods may yield no better than order-of-magnitude estimates of mobile LNAPL distribution at some sites (USEPA 540/S-95/500, 1995).

2) **Poor Design** may cause low LNAPL recovery by not allowing extraction at appropriate locations, depths or rates. This can result from improper screen placement. As indicated in the previous section, the physical and chemical characteristics of the LNAPL must be understood to properly design systems. Poor design is difficult to address once the system is installed.

3) **Insufficient or Excessive Water Table Drawdown and Operator Error** may prevent adequate volumes of LNAPL from entering the extraction well or trench. Excessive drawdown may smear LNAPL vertically across dewatered soils and convert mobile LNAPL to a relatively immobile phase which is difficult to recover. In addition, excessive drawdown may be accompanied by high water production rates.

Drawdown can be controlled using dedicated water level controllers on electrical pumps or water level controlled pneumatic pumps. Selection of the most appropriate pump and control for this application must be evaluated in the design phase of the project.

4) **Weather and Tidal Influences** can cause the depth of the water table to vary widely over a matter of hours. This can consequently affect the depth of the mobile LNAPL. Recovery systems which are not designed to automatically adjust to changing conditions may experience high water recovery and low LNAPL recovery during high water periods and may run dry during low water periods. Common approaches to this problem include:

- verification of weather and tidal effects;
- use of pump or passive collection devices with intakes which float within the LNAPL layer;
- use of hydrophobic conveyor belts which preferentially collect LNAPL from any depth at which it might occur within the well;
- for sites which have significant water handling capabilities, placement of the pump intake at the seasonal low water table elevation, pumpage of all water and oil

together and separation of oil and water in the treatment system; and use of separate pumps for oil and water recovery to maintain water and fuel levels at predetermined depths by varying ground water productions rates.

2.1.1.4 Excessive Water Production Based upon the definition of a successful LNAPL recovery system as one which maximizes LNAPL recovery while minimizing ground water recovery, excess water production may be a significant indication of poor system performance.

Primary causes of excess water production are:

- inappropriate pump selection and control setting;
- extraction of LNAPL and ground water simultaneously;
- failure to adequately control drawdown of the extraction unit; and
- lowering of pumps or pump control sensors further down wells to provide operational convenience at the cost of remedial effectiveness.

2.1.1.5 Inadequate Plume Capture A ground water extraction unit may be considered unsuccessful if the system does not capture the extent of ground water standard exceedances. *Note: Some systems are designed to only capture a portion of ground water standard exceedances because the regulatory agency has approved natural attenuation for portions of the plume.*

Plume capture applies in this context to both LNAPL and dissolved phase contaminants. Inadequate well placement/spacing can cause insufficient capture. Inadequate plume capture can also result from unexpectedly low extraction flow. This failure is primarily the result of two factors, (1) wells or trenches that are spaced too far apart, and (2) not having thorough understanding of site heterogeneities which can cause inaccurate modeling. These heterogeneities can be sand/gravel lenses, rock fractures and gravel fill surrounding utility conduits. Ground water models are frequently used to predict the capture zone of a well system. Over-simplification or errors in the use of these models may result in the specification of inappropriate well spacings. Misuse of models may also result in over-prediction of sustainable pumping rates and therefore inappropriate specification of pump, transport, and treatment systems. Zheng et al. (1991) and USEPA 600/2-93/118 (1993) provide guidance regarding choice of models.

2.1.2 Transport Unit Table 2-2 is a transport unit troubleshooting chart which describes the symptoms, problems, problem descriptions, and solutions for transport units. Flowchart 2-5 graphically identifies the problem identification process. The following is a discussion of the key issues.

- 1) **Poor Piping Design** may cause low injection rates if pumps and piping are undersized and incapable of transporting sufficient water for injection. This problem can be avoided in the design phase by appropriately sizing the discharge lines, accurately calculating pressure drops across the system and oversizing pumps and piping to allow for some fouling (which increases back-pressure).
- 2) **Inaccurate Elevation Data** resulting from erroneous or low resolution topographic data can result in a miscalculation of heads.
- 3) **Weather Variations May Affect Transport Systems.** Cold weather may freeze exposed or inadequately covered lines and wellheads. Hot weather may cause excessive line expansion, shifting and line breakage. Long pipe runs should be equipped with expansion loops to allow for this movement.
- 4) **Fouling/Encrustation** of lines may result in injection system failure. Observation of encrustation or fouling at the extraction well may provide appropriate warning that some accumulation may be occurring within transport lines. Monitoring of pressures, periodic inspection and cleaning may be required to minimize the potential for this to develop into a significant problem. Cleaning can include use of pigs or snakes which are inserted at header lines to remove partial obstructions. The O&M plan should include procedures and schedules for these activities.
- 5) **Poor Maintenance** of transport lines may lead to failure by corrosion, excessive thermal expansion, mechanical vibration, or exposure to weather.
- 6) **Physical Damage** to shallow piping systems and aboveground components may be caused by automobile traffic, airplane traffic, or heavy equipment. The design should provide protective measures around aboveground components and provide sufficient load bearing capacity for subgrade components. In addition, all utility company and maintenance personnel should be provided with maps depicting the location of subgrade components to prevent damage during unrelated excavation work. Many systems include signs indicating locations of buried piping. Access to the system by well workover equipment and maintenance vehicles will be required at some point and should be accounted for in the design.

7) **Sedimentation**, as with the fouling, may cause line plugging, treatment system damage and plugging of injection wells. Sediment traps and adequate cleanout mechanisms in the piping system will facilitate the removal of accumulated sediments.

8) **Construction Debris** that is inadvertently trapped in the piping system may lead to line plugging. Soil, rust scale, pipe thread tape, and welding slag are all common materials which find their way into systems during construction. The most effective approach to this problem is to employ an inspection process during construction. Prior to final piping fit up, the piping should be flushed with water to remove debris. Temporary screens are commonly installed in suction lines of pumps during startup.

9) **Incompatible Materials** may cause line failure. Hydrocarbons/ chemicals that are incompatible with some types of plastic pipe may result in the softening and collapse of pipes. Dissimilar metals that are placed in contact with each other may cause galvanic corrosion. Comparison of construction material compatibilities with chemicals at the site will minimize the potential for this problem.

10) **Improper Construction** or inadequate oversight practices may lead to decreased system performance. For example, piping runs that are installed unevenly can cause air to be trapped in lines. Also, low points missed during surveying or construction can trap sediments.

2.1.3 Injection Unit Recovered ground water is commonly treated and injected to improve flushing of contaminants, to allow addition of nutrients to promote biodegradation, or to provide a hydraulic barrier to contaminant migration. Contrary to common belief, injection is not the "reverse" of ground water extraction and sustainable ground water extraction rates are not a reliable indicator of sustainable injection rates. The major differences between extraction and injection are as follows:

1) Sustainable extraction rates are determined by the hydraulic conductivity and saturated thickness of the aquifer below the water table. Sustainable injection rates are determined by screen placement, the hydraulic conductivity and unsaturated thickness of materials between the water table and the ground surface.

2) Injection wells can sometimes be designed with larger slot openings than extraction wells because of less concern regarding siltation.

3) Well screens are exclusively designed to minimize head losses for water entering the well. Depending on the internal

geometry of the screen, injection wells may experience greater head losses than extraction wells.

4) The chemistry of injected water is often significantly different than that of the original ground water because of treatment steps, aeration and changes in temperature that occur after extraction.

5) Injection can occur under gravity feed or pressure feed conditions.

Table 2-3 is an injection system trouble-shooting chart which describes the symptoms, problems, problem descriptions, and solutions for injection systems. The following references provide guidance regarding ground water injection: Driscoll, USEPA OSWER Directive 9355.4-03, 1989, USEPA 600/2-79/170, 1979, USEPA 600/S8-87/013, 1987, USEPA 600/2-77/240, 1977, USEPA 625/R-94/003, 1994, and USEPA 600/S8-88/008, 1988.

2.1.3.1 Low Injection Rates Poor injection capacity is the inability of the well to allow the necessary flow rates back into the formation. Generally, it is more difficult to return ground water to the aquifer than to remove it. As a result, the injection system must be designed with excess capacity. This may include flexibility for conversion from gravity feed to pressurized injection.

Poor well design may result in low injection rates. Consideration must be made for the desired flow rate combined with the ability of the aquifer to accept the flow. This requires an adequate understanding of hydrogeologic conditions and factors listed in the previous section.

2.1.3.2 Injection Rates Falling Operational monitoring may reveal that injection rates are decreasing over time. Decreasing injection rates should prompt an evaluation of the following issues:

1) **Encrustation/Fouling/Precipitation** in the well screen or formation may lead to falling injection rates over time. This problem will likely be observed in injection wells first, because the area available for water to be injected is limited by the area of the surface of the bore hole. Both the screen and the filter pack in a properly designed well are so permeable as to provide little resistance when compared to the formation at the bore hole interface. Although a well in a one foot diameter boring would have a surface area of 3.14 square feet per foot of screen length, only a portion of that surface is pores. The ability to block off those pores with particles is inversely related to the diameter of the pores. Consequently, both fine grained and well graded formations have smaller pore throats and are more susceptible to clogging by suspended particles or gas

bubbles entrained in the water (see Figure 2-1). However, precipitation problems may also manifest themselves downstream of the treatment system due to changes in water chemistry. Changes in water chemistry may also affect the formation, causing changes to formation clays that cause the wells to become plugged. The following are problems with injection well clogging that are commonly limiting factors on the viability of the well:

- Calcium carbonate incrustation created by rising pH following treatment such as air stripping.
- Iron and manganese precipitation under oxidizing conditions.
- Sediment entrained in the injection water.
- Bacterial contamination.
- Chemical reactions between ground water and recharge water of different quality.
- Mechanical jamming caused by reversal of water movement in the vicinity of the well.
- Clay swelling and clay dispersal from injected water.
- Air entrainment in the recharge water.
- Viscosity changes from differences in water temperature between ground water and recharge water.

Refer to Olsthoorn 1982 for further detail on the fouling of recharge wells.

DWG. NO. 90000079

INJECTION WELL CROSS SECTION

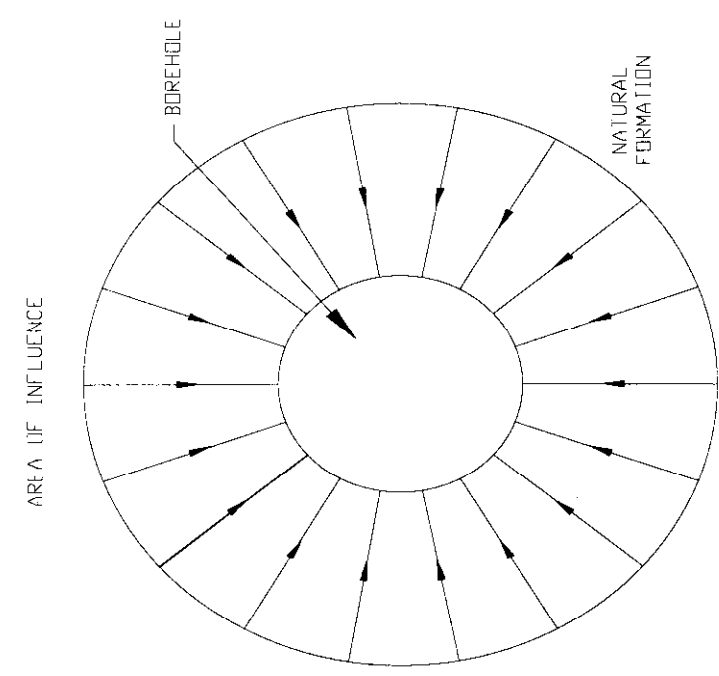
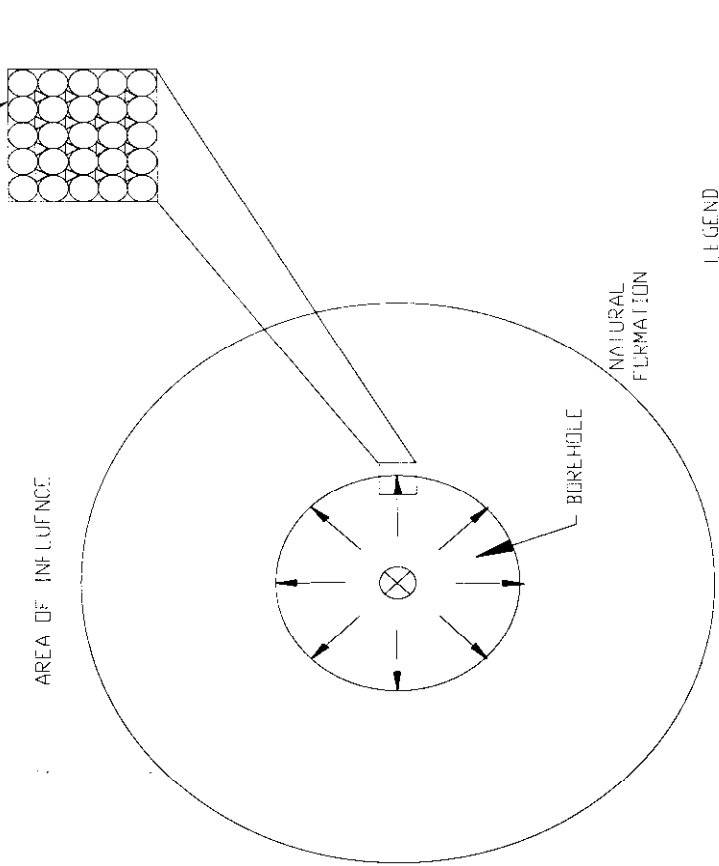

LEGEND

○ NATURAL FORMATION PARTICLES

∇ INJECTED PARTICLES OR ENTRAINED GAS BUBBLES WHICH OCCUPY PURE SPACES

INJECTION WELL

EXTRACTION WELL

THE NUMBER OF PATHWAYS FOR WATER TO BE INJECTED INTO AQUIFER IS LIMITED BY AREA OF BOREHOLE FORMATION INTERFACE, AND THE EFFECTIVE POROSITY OF THAT INTERFACE.

THE NUMBER OF PATHWAYS FOR WATER TO ENTER WELL IS LIMITED BY MOVEMENT OF WATER IN FORMATION TO WELL SCREEN

FIGURE 2-1

Installation of de-aeration systems and pH adjustment systems can be used to minimize encrustation. In addition, silt traps can be used to remove solids conveyed from the extraction wells or which form in-line prior to entry into injection wells. Installation of drop pipes to ensure that water does not cascade into the well can also help to minimize formation of some minerals. The O&M plan should include periodic inspections of well screens via downhole camera and appropriate well redevelopment schedule to maximize injection rates. When trouble-shooting or designing injection systems, consider the advantages of injection trenches over injection wells. Injection trenches are easier and less expensive to install, and require less maintenance for optimum operation than injection wells.

2) Nutrient and Dissolved Oxygen Interaction with the Aquifer

The addition of nutrients to the aquifer (during in-situ biotreatment) may result in biological growth in the formation around injection wells. Over time, this biological growth may block off the aquifer. Periodic or constant feed chemical treatment of the injected water to kill bacteria or retard their growth is one approach to this problem. However, this approach may be contrary to the objective of promoting biological treatment in the formation and may not be permitted by UIC rules or regulations.

3) Improperly Constructed Injection units may lead to decreased performance over time. A common error in design of pressure injection wells is the use of PVC riser pipe. Although the material may be rated to withstand injection pressures, slight contraction and expansion of the casing as injection pressures vary can result in failure of the grout seal. Failure of the grout seal results in short circuiting of injected water to the surface and inability to force water into the aquifer under pressure. Therefore, while it may be appropriate to use PVC in gravity-feed injection wells, it is rarely advisable to use PVC in the construction of pressure injection wells.

2.1.3.3 Plume Redirection Injection of ground water is often performed to flush the existing contaminant plume towards extraction wells. In some instances, injection may not successfully accomplish this objective. The following situations may lead to this failure:

1) Injection Wells Improperly Located due to site constraints, inadequate characterization or improper modeling may lead to misdirection of the plume. An adequate understanding of the hydraulics created by the desired injection program is critical in avoiding this problem. Injection testing is necessary to minimize the chances for this problem. The results of this testing should be used to calibrate ground water models constructed to choose well placement and specify water balances. In addition, potentiometric monitoring points should be installed

to gauge whether the desired result is being achieved and to aid in specification of operational adjustments.

2) **Incorrect Water Balance**, or poor understanding of where the system's water is coming from may lead to a shift in the contaminant plume. This situation may develop in shallow aquifers that are not continuous or vary in their capacity to produce and accept water across the project site. This problem is generally a result of the lack of adequate site characterization.

TABLE 2-1
Ground Water Extraction/Transport/Injection System Problems
and Possible Causes

Extraction Unit	Surface Transport System	Injection System
<p>1) LOW WATER PRODUCTION (Initial) Inadequate hydrogeologic characterization Improper well design Incorrect well installation/material selection Pump/pumping size Wrong pump type Improper pump control and intake settings Well location Improper well development</p>	<p>1) TRANSPORT/PIPING PARTIAL/COMPLETE BLOCKAGE Poor design and installation Weather Fouling/encrustation Poor maintenance Physical damage Sedimentation Construction debris Incompatible materials Air bubbles Air accumulation in high points Freezing Leaks due to improper installation</p>	<p>1) LOW INJECTION RATES Wrong well design Inadequate characterization Inadequate injection capacity Pump/piping design</p>
<p>2) LOW CONTAMINANT MASS REMOVAL Inadequate characterization Incorrect design; well/screen depth Improper pump type/size Too little/too much drawdown Tidal/weather fluctuations during NAPL recovery</p>	<p>2. FREQUENT LINE RUPTURES Poor Design Weather/UV Degradation/Corrosion Incompatible materials Pressure surges</p>	<p>2) INJECTION RATES FALLING Encrustation/precipitation Nutrient interaction with aquifer Dissolved oxygen interaction with aquifer Transport of air bubbles into aquifer Transport of suspended solids into aquifer Biological fouling/growth blocking well</p>
<p>3) PRODUCTION RATE FALLING Encrustation/fouling Well placement Siltation Pump impeller wear Weather; seasonal low water table Incompatible well screen</p>		<p>3) PLUME REDIRECTION Injection wells improperly located Inadequate characterization Water balance/injection balance</p>

TABLE 2-1 (Cont'd)

Ground Water Extraction/Transport/Injection System Problems
 and Possible Causes

Extraction Unit	Surface Transport System	Injection System
<p>4) EXCESS WATER PRODUCTION Pump size Inadequate characterization Improper design</p>		<p>4) MOUNDING/FLOODING Inadequate characterization/design Operational/problems Encrustation Sedimentation Construction debris Weather; seasonal high water table Incorrect pressure/level control settings Biological fouling/growth blocking well</p>
<p>5) INADEQUATE PLUME CAPTURE Improper design Pumps too small Pumps too large, excessive cycling Inadequate characterization/modeling Poor placement/spacing of wells Plume movement during construction delays</p>		
<p>6) HIGH CONTAMINANT LOADING Inadequate characterization/modeling Poor placement/spacing of well</p>		

Note: Low, excess and inadequate trends are defined by comparison to performance criteria and baseline performance

TABLE 2-2

Extraction Unit Troubleshooting

Symptom	Problem	Description	Solution
Initial Water Production Lower than Design	Poor Characterization	Poor/incorrect characterization leading to inaccurate modeling and/or design	Proper determination of site stratigraphy and hydrogeology, re-evaluation of modeling/design basis and determination of well yields
	Well Design	Inappropriate design including incorrect drilling methods well/screened interval, materials, pump type or size	Re-evaluation of design parameters
	Insufficient Development	Poor development leading to silting of well and blockage of filter pack and screen	Redevelop wells using procedures appropriate for aquifer and well
	Pump Too Small/Wrong Pump Type	Pumps operating at rated capacity but not producing expected amount of water	Install larger pumps or change to pump type that can produce the required amount of water; install additional wells; check the proper pump control settings
	Pump Too Large/Wrong Pump Type	Pumps producing more water than aquifer can yield causing excessive cycling and cause siltation	Install smaller/lower flow pumps; or lower pump rate and/or trim the impellers
	Physical Damage/Blockage	Well/pump damaged during installation, discharge line kinked or blocked with construction, debris	Inspect pumps and discharge piping for leaks/damage/blockage; determine if screen/well is physically blocked
	Incorrect Pump Control and Intake Settings	The pump intake or low level control is not placed deep enough in the well to take advantage of available drawdown.	Reset the pump intake or low level control to a greater depth.

TABLE 2-2 (Cont'd)
Extraction Unit Troubleshooting

Symptom	Problem	Description	Solution
Water Yield Decreasing Over Time	Mineral Encrustation	Well screens, pump inlets, level controllers, discharge piping blocked with mineral encrustation	Treat system with appropriate acid treatment on a periodic basis as part of maintenance program, redevelop well using jetting methods, re-evaluate well design/pump placement based upon geochemistry
	Biological Fouling	System components blocked with biological mat	Treat system with appropriate biocide as part of periodic maintenance, evaluate installation of permanent well disinfection systems, re-evaluate well design/pump placement
	Siltation	Well accumulating silt leading to less available screen area and/or erosion of pump impellers	Redevelop well as necessary
	Weather	Drought conditions causing lowering of water table	Lower pump, temporarily shut down system
	Incompatible well/pump components	Well/pump materials affected by ground water or contaminants leading to blockage or physical damage	Replace affected components, change pump type, install new wells using appropriate materials
	Well Spacing	Recovery wells located too close together; capture zones too large	Install well level controllers to limit drawdown, trim impeller/install smaller pumps or decrease number of pumping wells
Low Contaminant Mass Removal	Poor Characterization	Wells missed plume, wells screened at wrong depth or pumps placed at wrong depth to capture NAPL	Adjust pump depths, convert well to other use (water level, monitor wells), install new wells

TABLE 2-2 (Cont'd)
Extraction Unit Troubleshooting

Symptom	Problem	Description	Solution
Low Contaminant Mass Removal (continued)	Poor Design	Pumps/recovery system inappropriate for contaminants	Re-evaluate design based upon new data, install new wells
	Too Little Drawdown	Capture zone smaller than anticipated resulting in less water/NAPL removal	Move pump/level controllers, change pump size/type
	Tidal/Weather	Tidal fluctuations causing water/LNAPL levels to rise above/below screen, drought,/flooding affecting water level	Adjust pump depths, temporarily shut down system
Excess Water Production	Poor Characterization and/or Design	NAPL recovery well producing more water than expected	Adjust pump depths, change pump type, re-evaluate design based upon current information
Inadequate Plume Capture	Poor Characterization and/or Design	Capture plumes not as large as planned	Re-evaluate design based upon current information
	Pumps Too Small	Pumps cannot remove sufficient water to establish planned capture zone	Install larger/different type of pumps, re-evaluate design
	Pumps Too Large	Excessive cycling of pumps prevents establishment of capture zone or causes excessive pump failures	Install smaller/different type of pumps, re-evaluate design
	Well Placement or Spacing	Poor well placement and/or spacing prevents establishment of adequate capture plume	Re-evaluate wells, install additional wells
	Plume Movement During Regulatory Approval or Construction Phase	Plume continues to move during regulatory review or during system construction and startup	Re-evaluate system design based upon current plume location, install additional wells, increase flow from existing wells
High Contaminant Loading	Poor Characterization	NAPL, higher contaminant concentrations identified during system installation	Re-evaluate design, modify system to handle high contaminant loads, limit recovery system to balance contaminant loads

TABLE 2-3

Transport Unit Troubleshooting

Symptom	Problem	Description	Solution
Air/Water Line Low or No Flow	Encrustation/Fouling	Discharge and/or injection lines plugging, pneumatic air lines plugging	Soften water/biological treatment systems where appropriate, chemically treat lines as part of periodic well maintenance, install filters, dryers on air system, construct lines out of materials appropriate for use.
	Sedimentation	Slow flow rates allow accumulation of sediment in discharge lines	Design appropriate system based upon expected flow velocities, install filters and clean out ports, install crossovers to allow lines to be blown out with compressed air
	Poor Design	Length, size, number of turns/valves increase likelihood for sedimentation and encrustation, system components incompatible with contaminants, air locks in piping can cause plugging	Evaluate design and location of equipment, install filters/chemical treatment systems, install system with compatible components, design piping with air release valves.
	Construction Debris	Construction debris remaining in system prevents effective operation	Clean and water flush lines prior to final assembly
	Weather	Lines freezing during cold weather; lines expanding, crackling or dislocating due to expansion during warm weather	Appropriate design based upon expected weather conditions, install lines below grade, insulate and heat-trace lines for freeze protection and/or expansion loops as necessary

TABLE 2-4
Injection Unit Troubleshooting

Symptom	Problem	Description	Solution
Low Injection Rates	Poor Characterization	Incorrect characterization leading to aquifer not taking sufficient water	Proper determination of well yield
	Poor Design	Wells/injection system design limits amount of water that can be injected	Proper design based upon good characterization; evaluate design and modify system
	Inadequate Injection Capacity	Insufficient number of injection wells to handle quantity of water produced	Install additional wells, limit water recovery, modify well design, consider infiltration basins and injection trenches when adding injection capacity.
Falling Injection Rates	Encrustation/Fouling	Mineral encrustation and/or biological fouling plugging injection wells and piping	Rehabilitate wells with appropriate chemicals; soften water/biological treatment systems; select appropriate materials of construction
	Treatment System Nutrients/Additives Reacting with Aquifer	Additives added during treatment reacting with aquifer material and causing excessive fouling/mineral precipitation	Evaluate additive quantities and injection locations, change additive types
	Sedimentation	Slow flow rates allow accumulation of sediment in discharge lines	Design appropriate system based upon expected flow velocities, install filters and clean out ports, install crossovers to allow lines to be blown out with compressed air

TABLE 2-4 (Cont'd)
Injection Unit Troubleshooting

Symptom	Problem	Description	Solution
Falling Injection Rates (continued)	Poor Design	Length, size, number of turns/valves increase likelihood of sedimentation and encrustation, system components incompatible with contaminants	Evaluate design and location of equipment, install filters/chemical treatment systems, install compatible components
Injection Pushing Plume in Wrong Direction	Poor Characterization	Location of injection wells pushing plume away from recovery wells	Install additional injection wells in more appropriate locations, evaluate amount of water being injected in each well
	Water Balance	Some wells taking more water than others causing the plume location to shift	Install additional injection wells in more appropriate locations, evaluate amount of water being injected at well locations
Mounding/Flooding	Poor Characterization and Design	Aquifer not able to handle the amount of water to be injected	Install more wells, evaluate depths and well materials, limit amount of water to wells and infiltration galleries, evaluate other discharge options
	Encrustation/Fouling	Fouling of wells limiting the amount of water that can be injected; fouling of level controls allowing overflows	Chemical treatment of water prior to injection
	Operation and Maintenance Problems	Damage and deterioration of system components allowing excessive injection rates	Evaluate O & M program, perform periodic maintenance

Figure 2-2
Troubleshooting Flow Chart
Low Initial Water Extraction Rate
Sheet 1/3

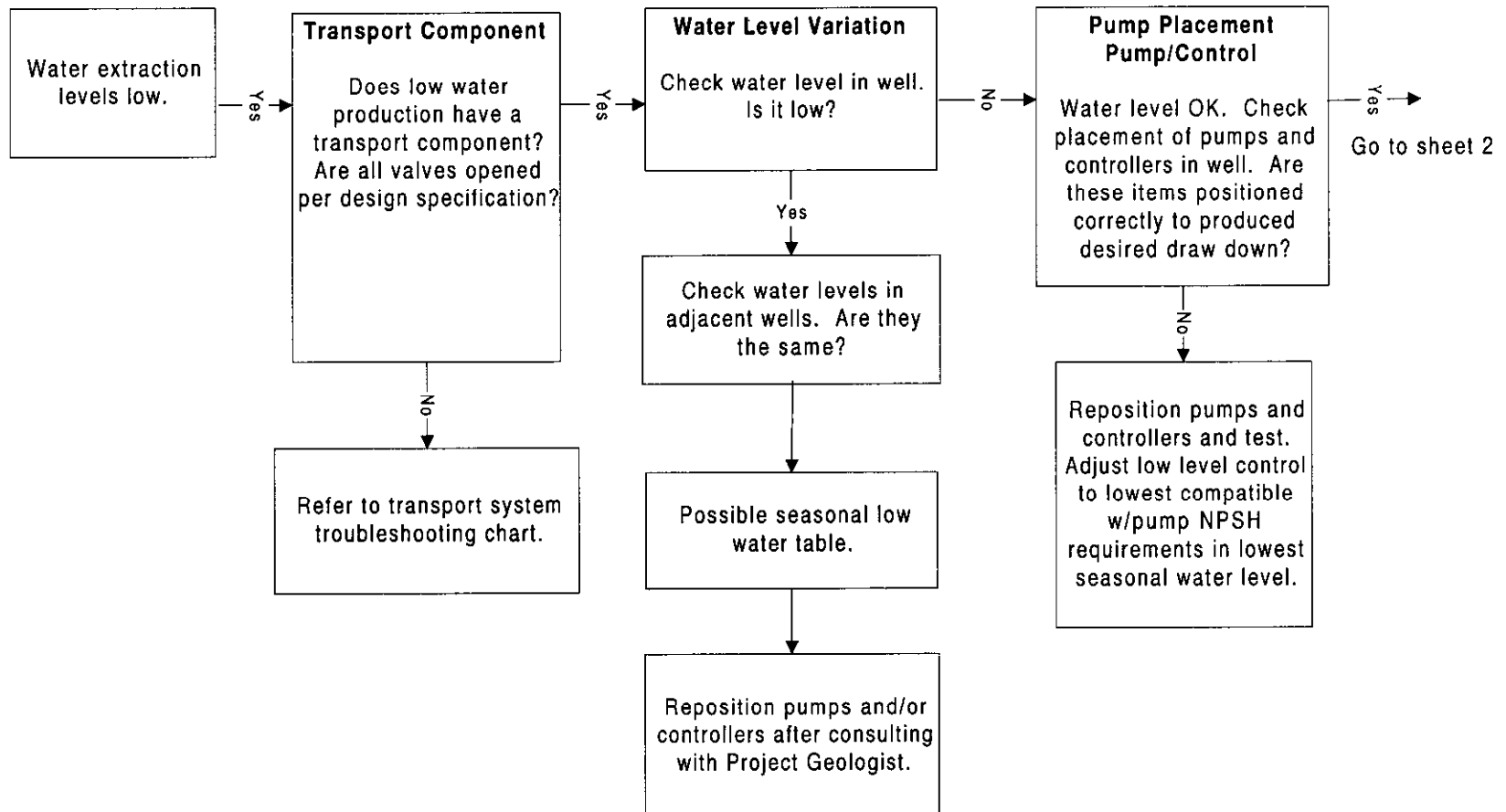

2-27

Figure 2-2
Troubleshooting Flow Chart
Low Initial Water Extraction Rate
Sheet 2/3

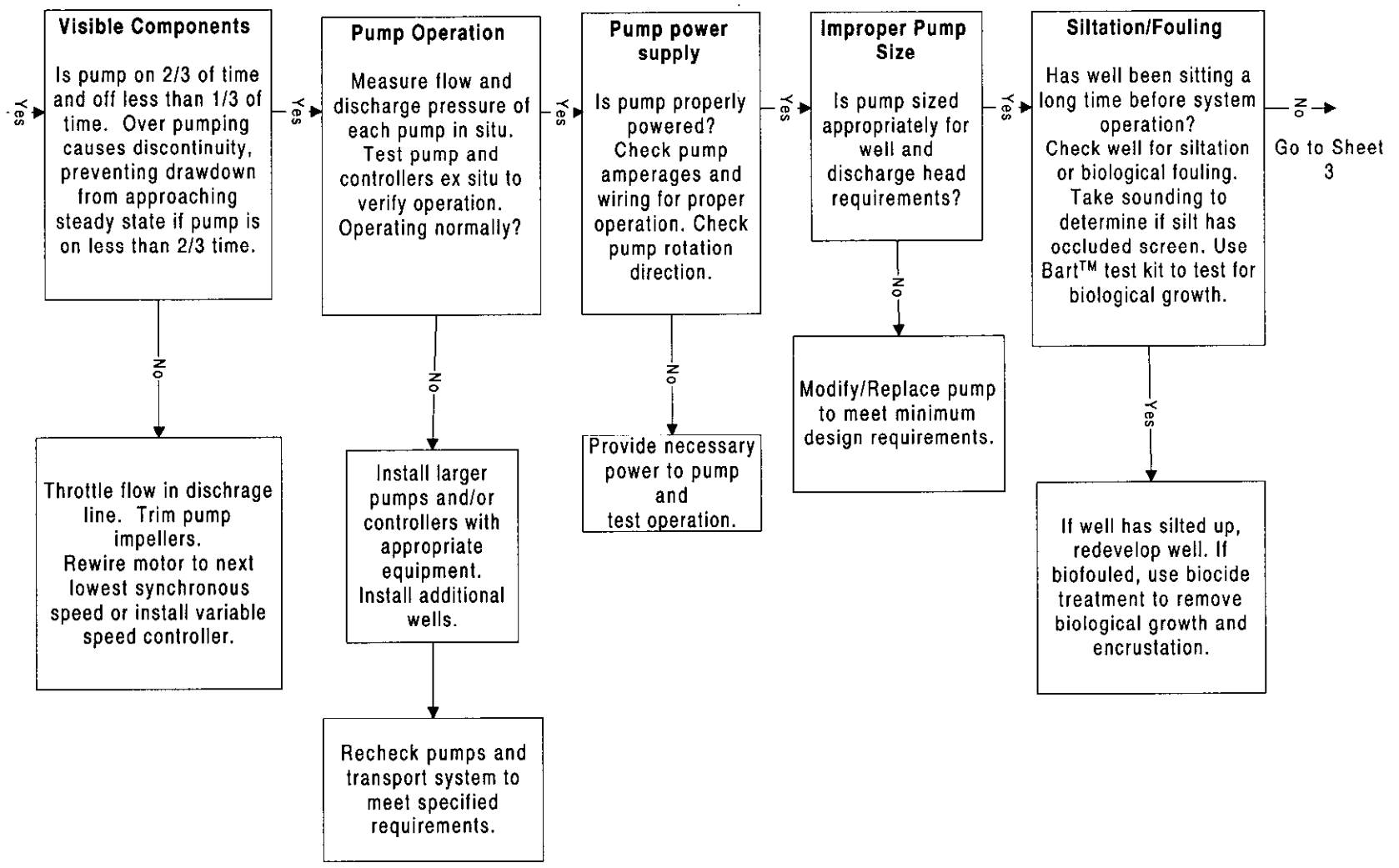
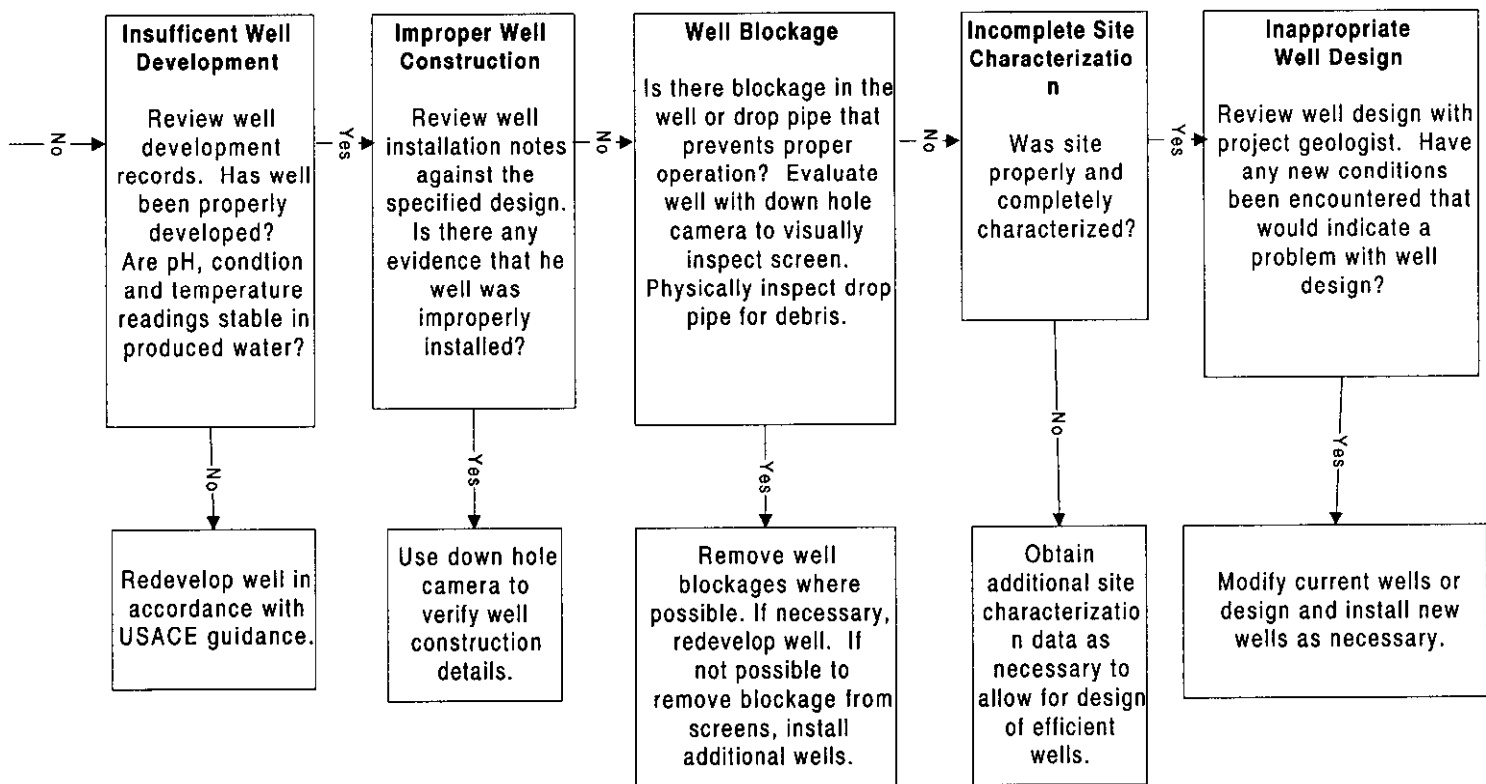

Figure 2-2
Troubleshooting Flow Chart
Low Initial Water Extraction Rate
Sheet 3/3



2-29

Figure 2-3
 Troubleshooting Flow Chart
 Water Extraction Rate Declining Over Time
 Sheet 1/2

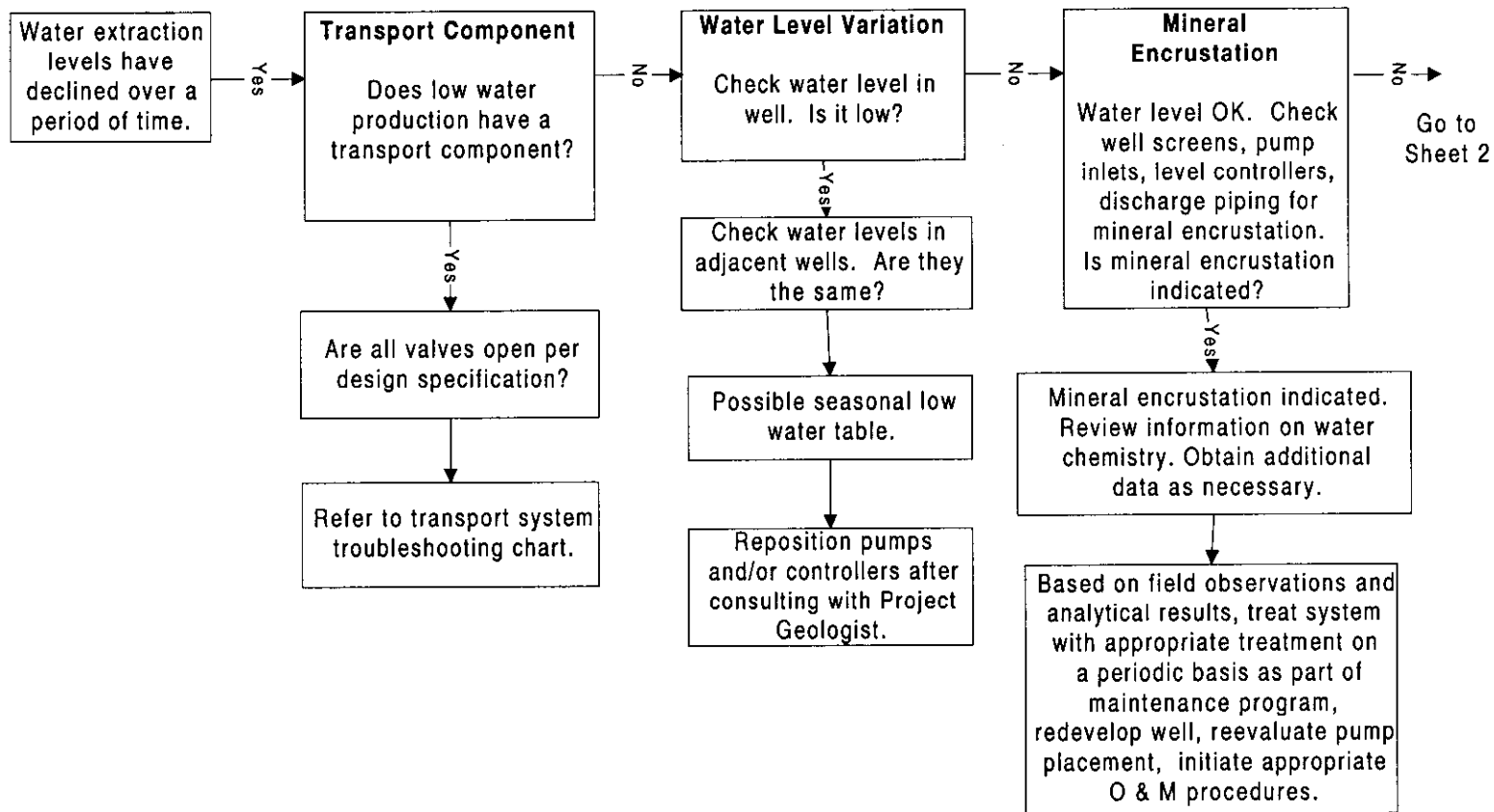
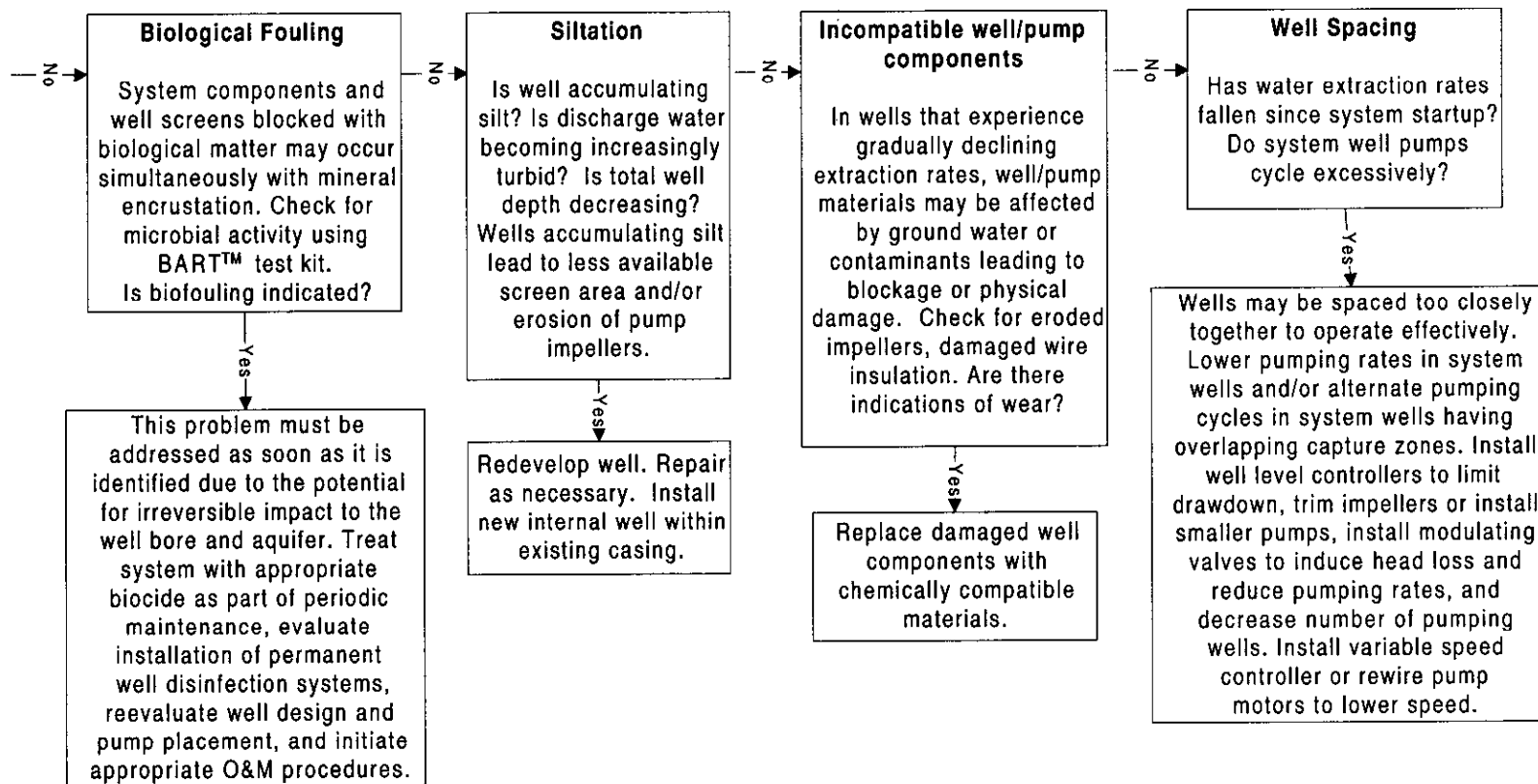
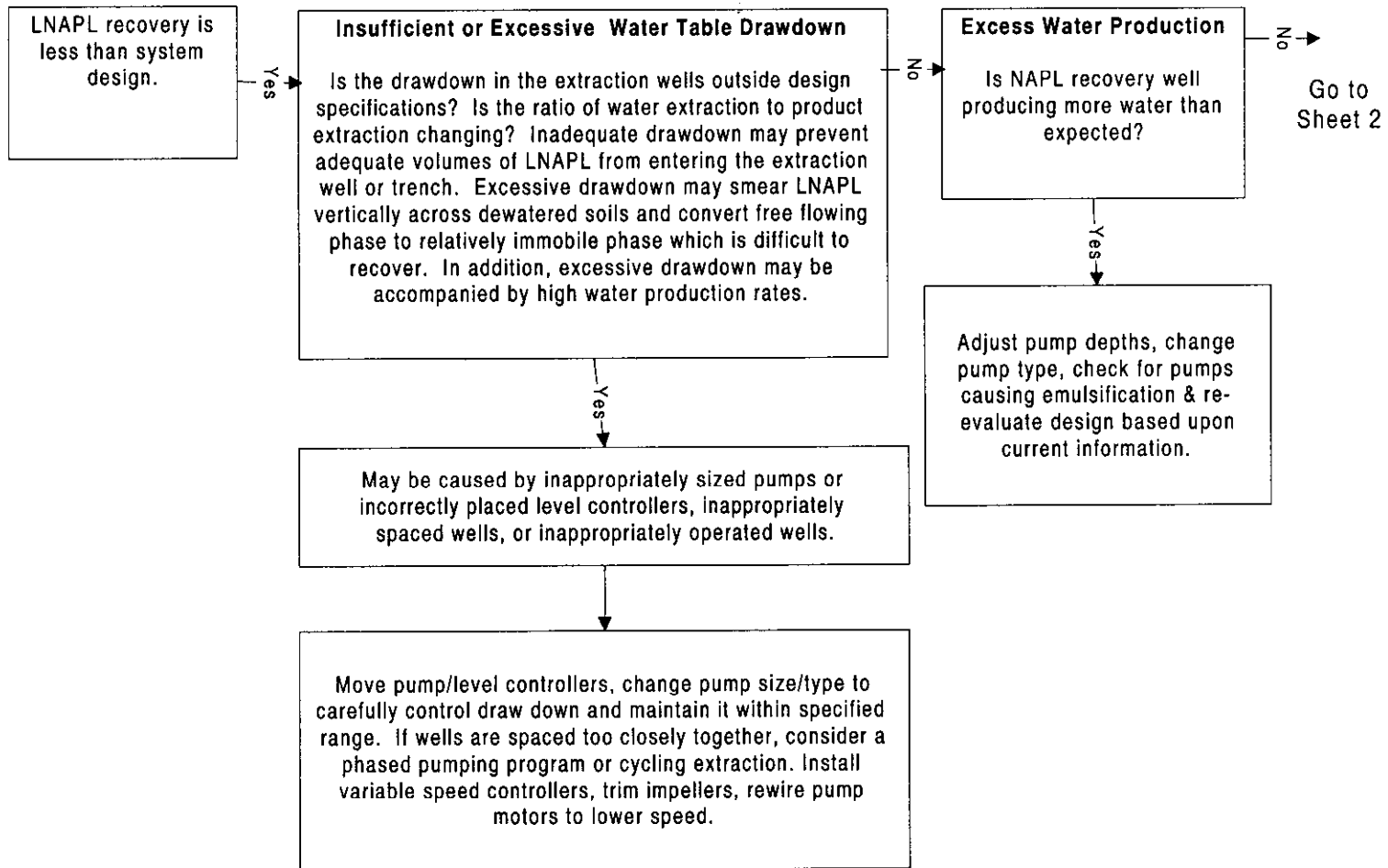

Figure 2-3
Troubleshooting Flow Chart
Water Extraction Rate Declining Over Time
 Sheet 2/2



2-31

Figure 2-4
Troubleshooting Chart - Extraction Unit
Low LNAPL Removal Rates
Sheet 1/2



2-32

Figure 2-4
Troubleshooting Chart - Extraction Unit
Low LNAPL Removal Rates
Sheet 2/2

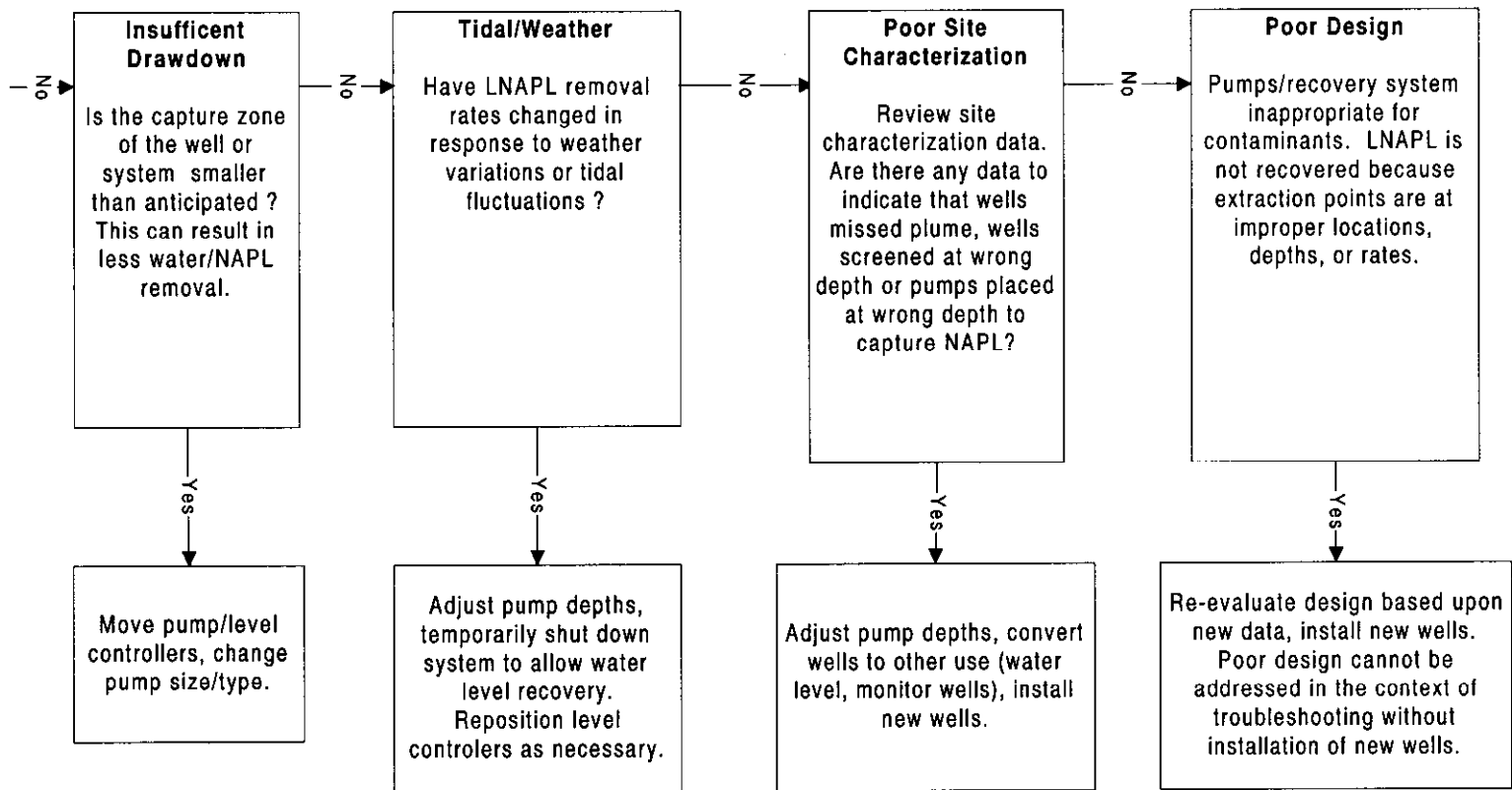

2-33

Figure 2-5
Troubleshooting Flow Chart
Extraction System / Inadequate Plume Capture

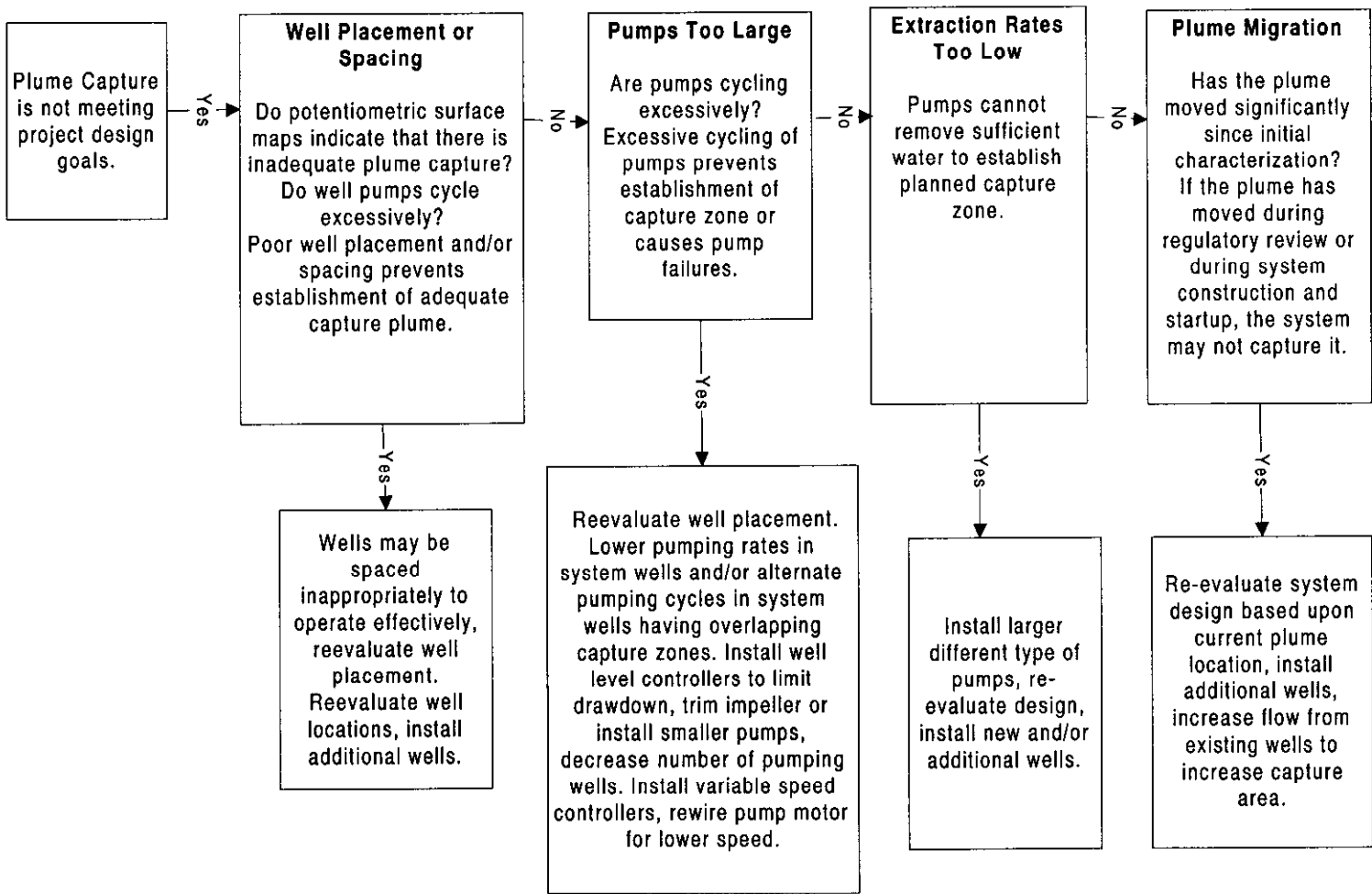
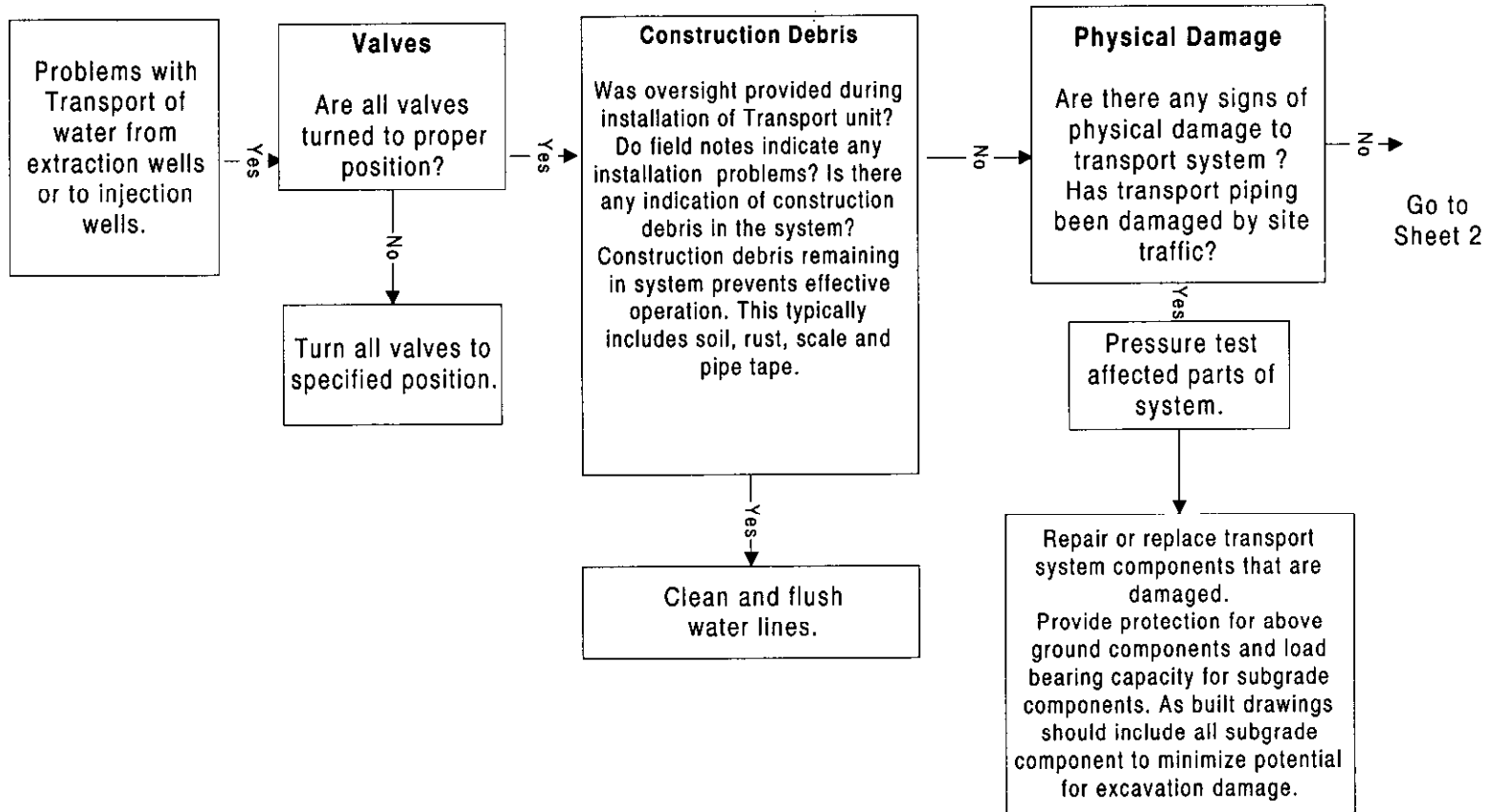
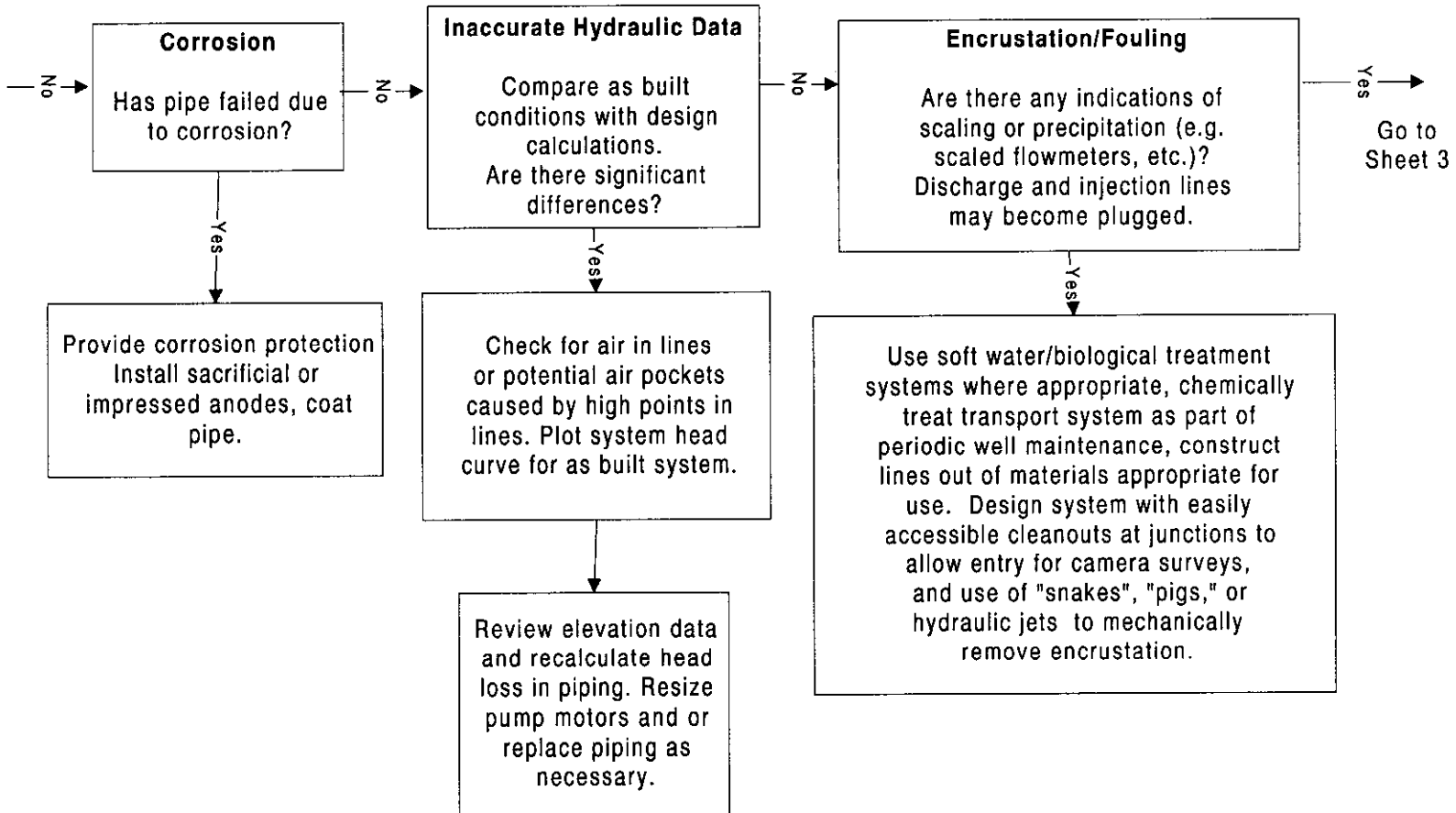

Figure 2-6
Transport Unit Troubleshooting
Sheet 1/3



2-35

Figure 2-6
Transport Unit Troubleshooting
Sheet 2/3



2-36

Figure 2-6
Transport Unit Troubleshooting
Sheet 3/3

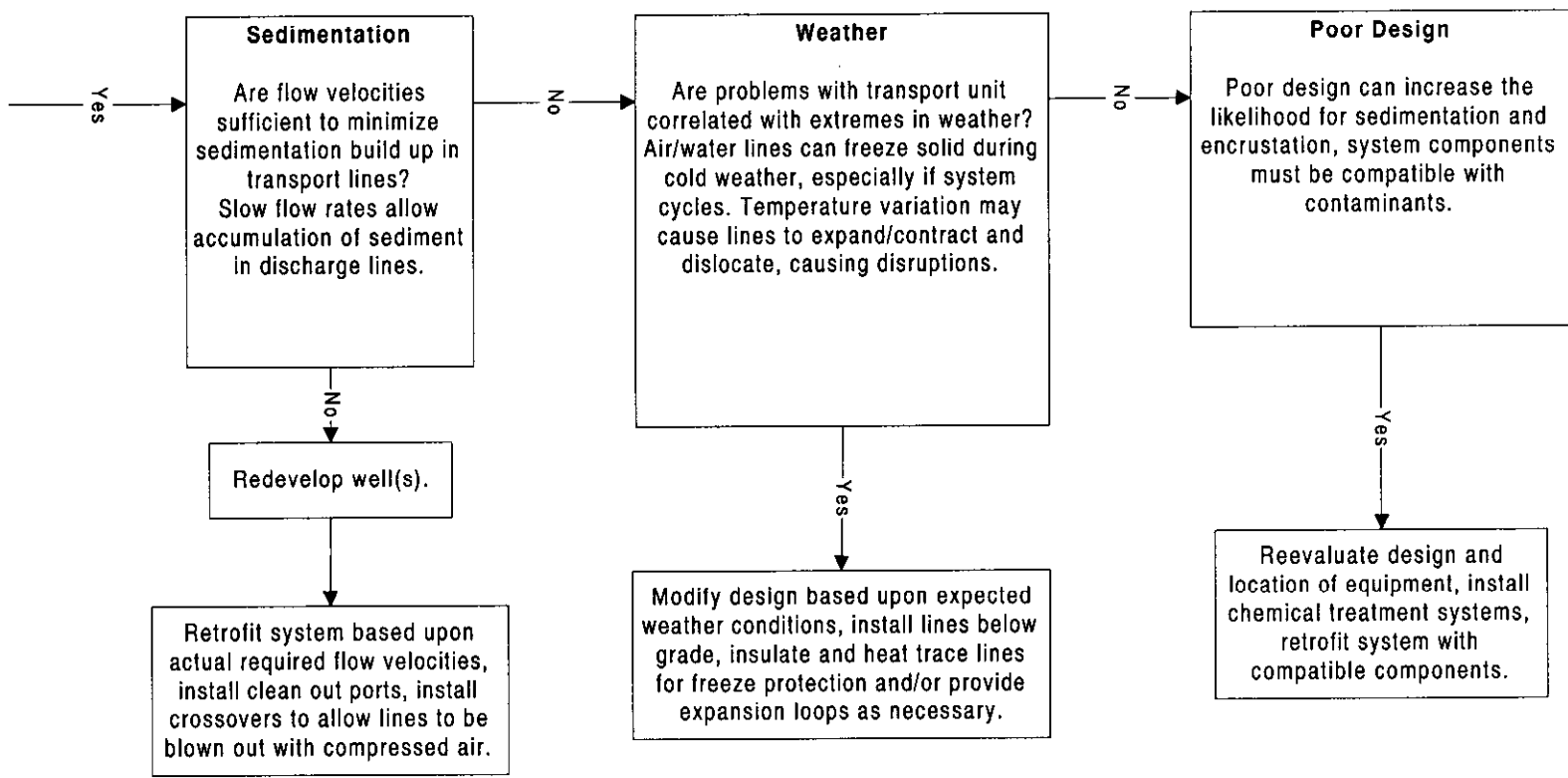

2-37

Figure 2-7
Injection Unit Troubleshooting
Low Initial Injection Rates
Sheet 1/3

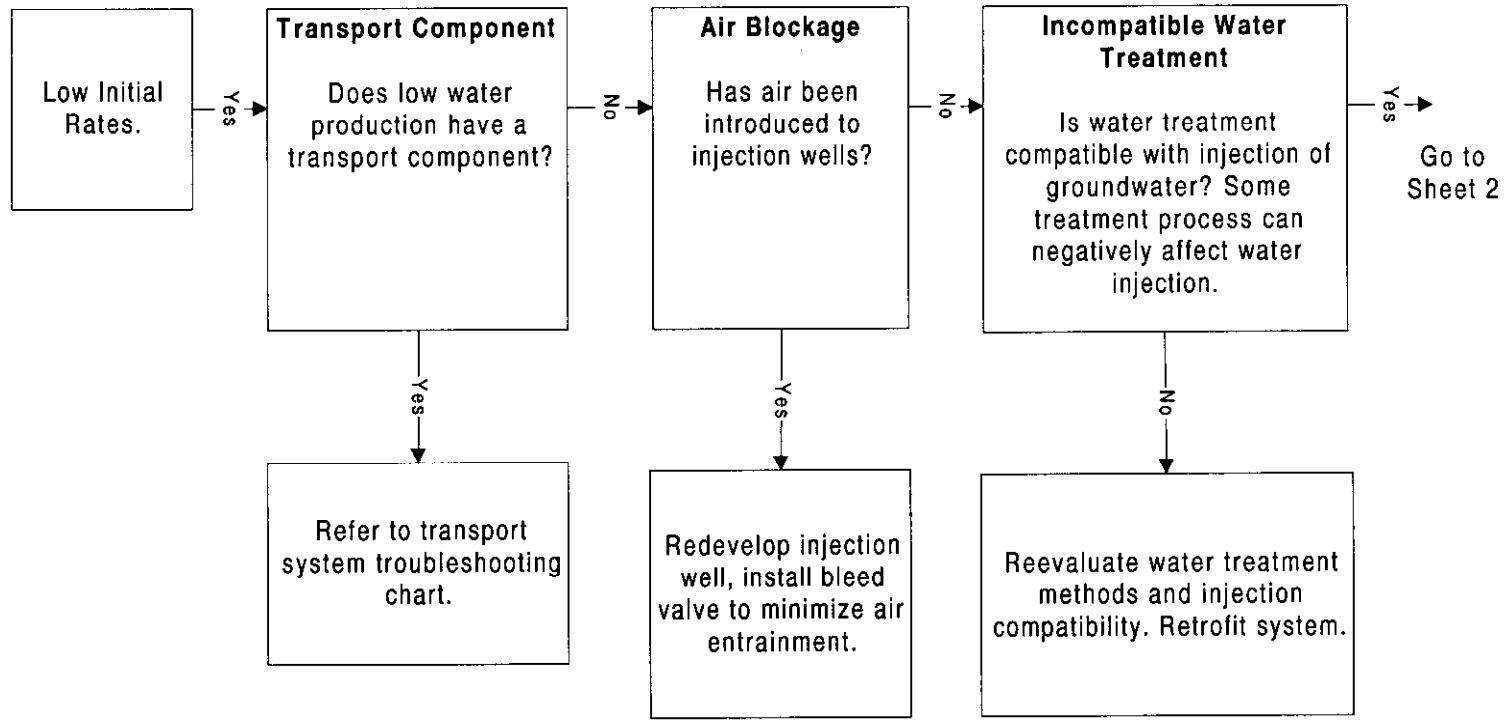
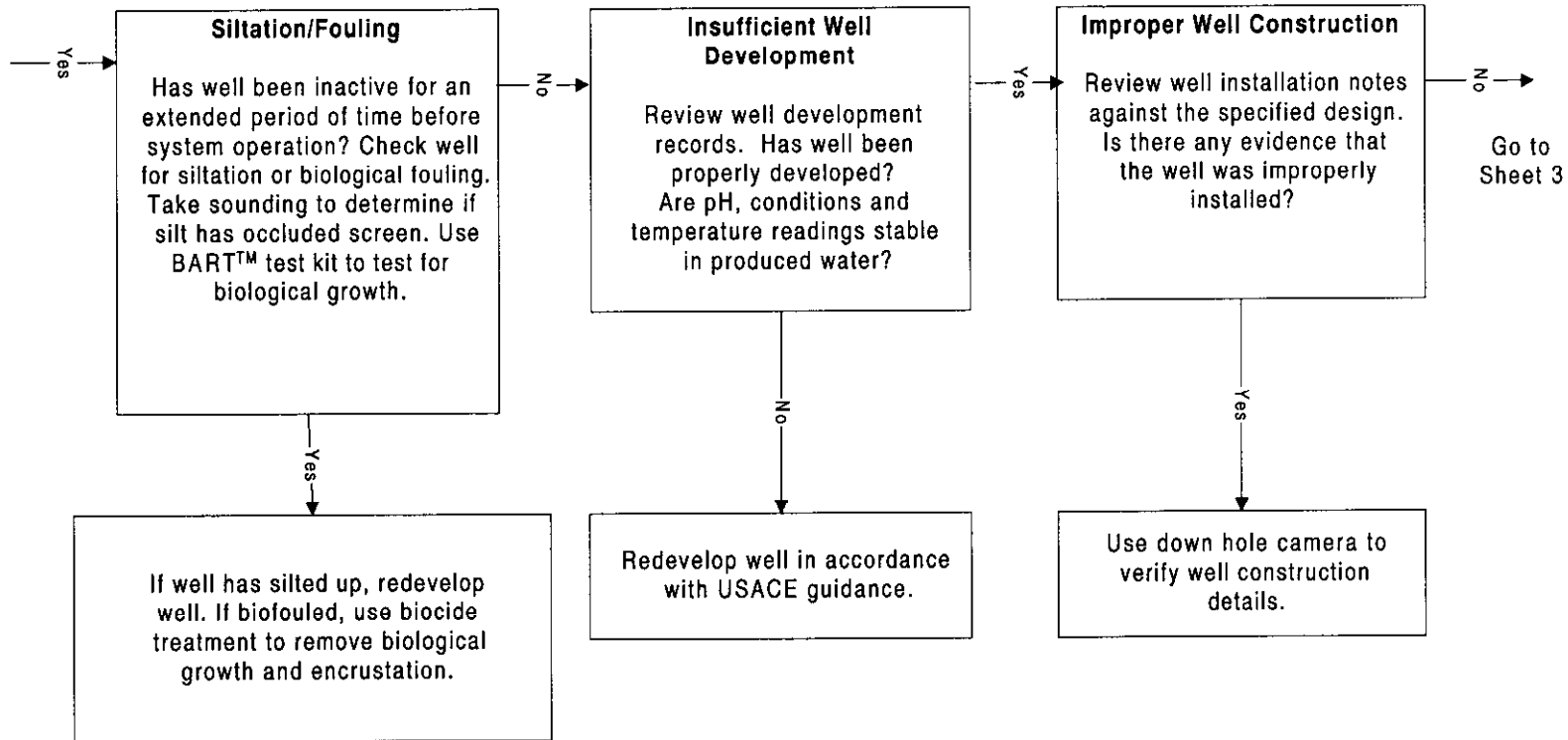
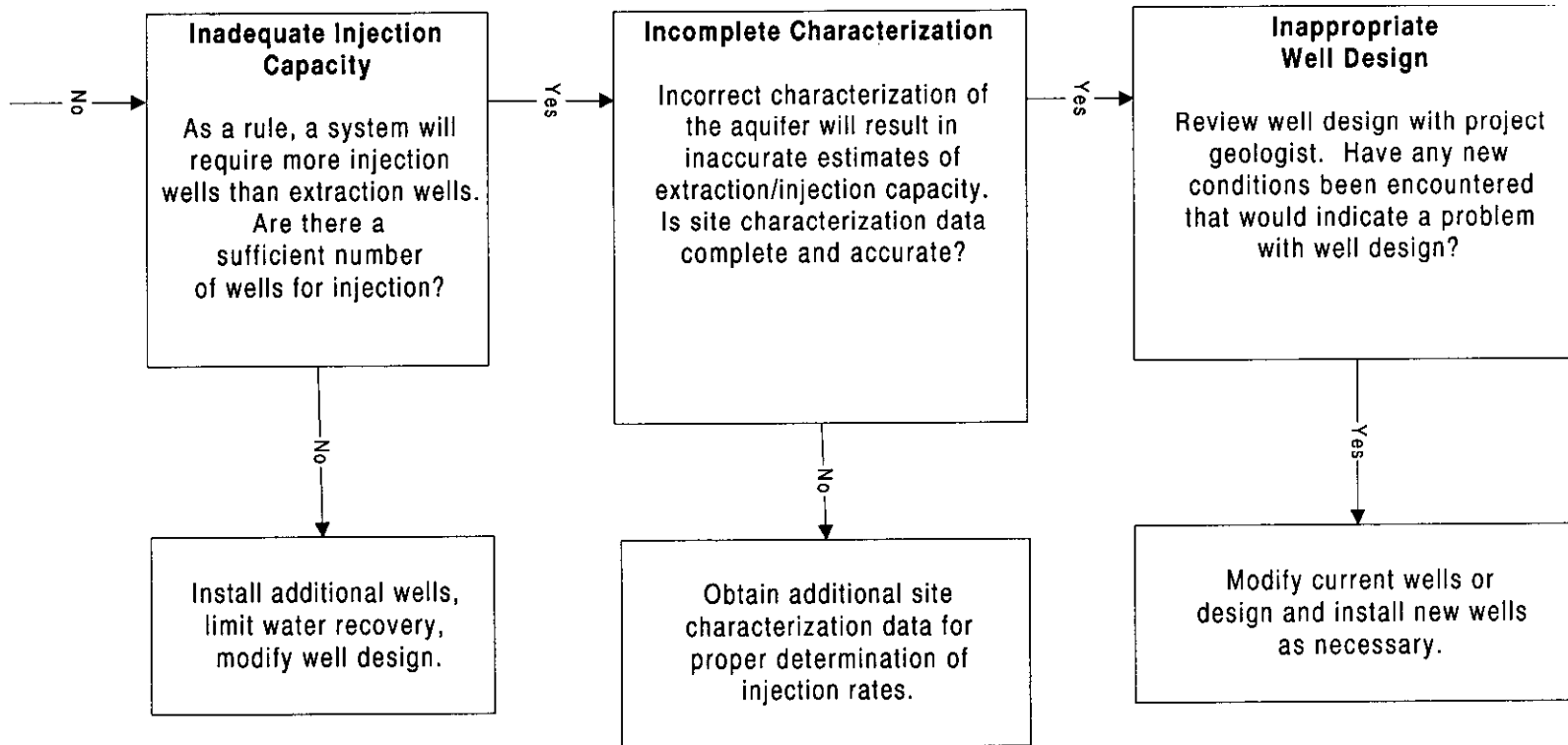

Figure 2-7
Injection Unit Troubleshooting
Low Initial Injection Rates
Sheet 2/3



2-39

Figure 2-7
Injection Unit Troubleshooting
Low Initial Injection Rates
Sheet 3/3



2-40

DG 1110-1-1
12 NOV 99

Figure 2-8
Troubleshooting Flow Chart
Injection Rate Declining Over Time
Sheet 1/2

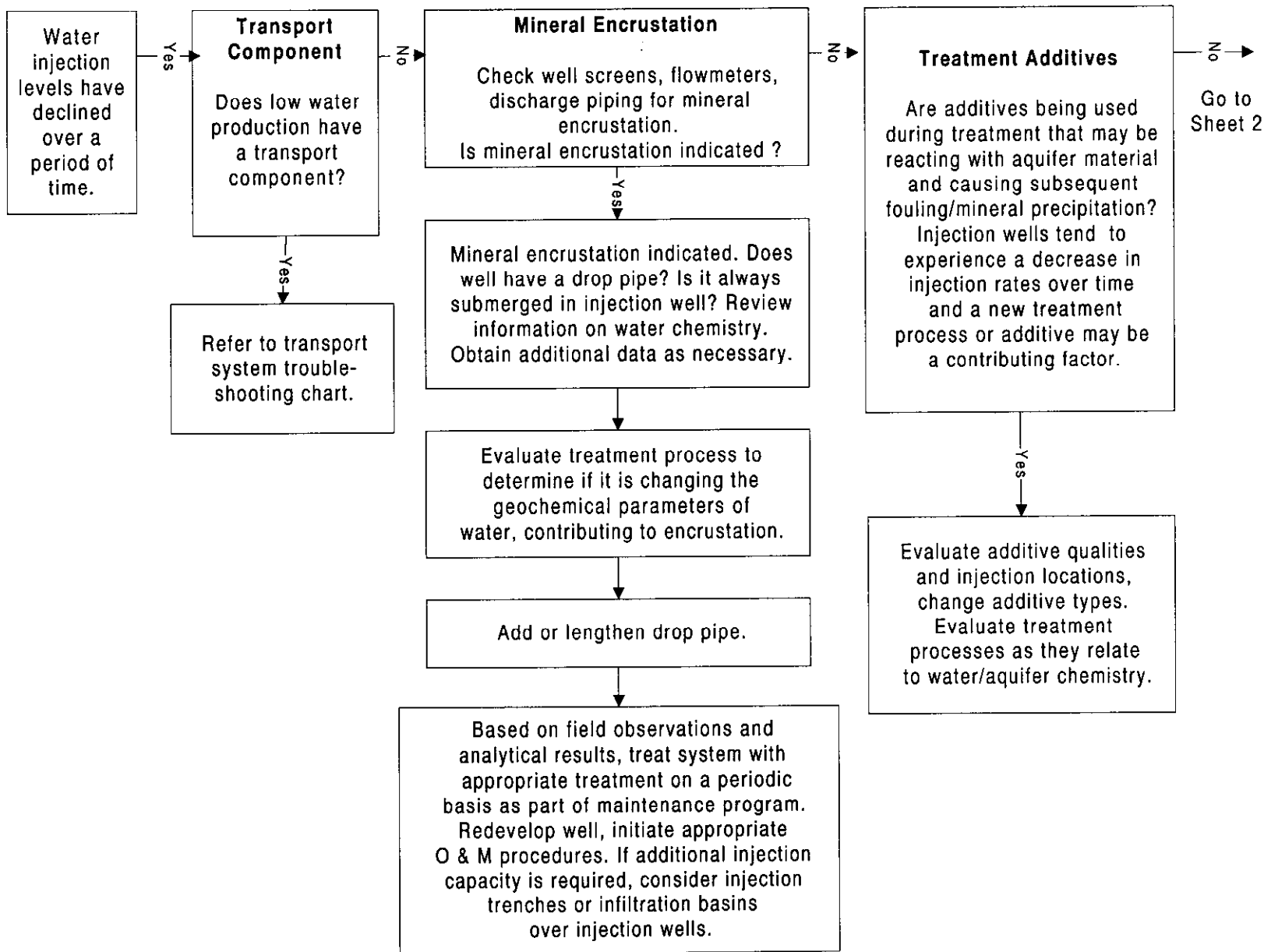

2-41

Figure 2-8
Troubleshooting Flow Chart
Injection Rate Declining Over Time
Sheet 2/2

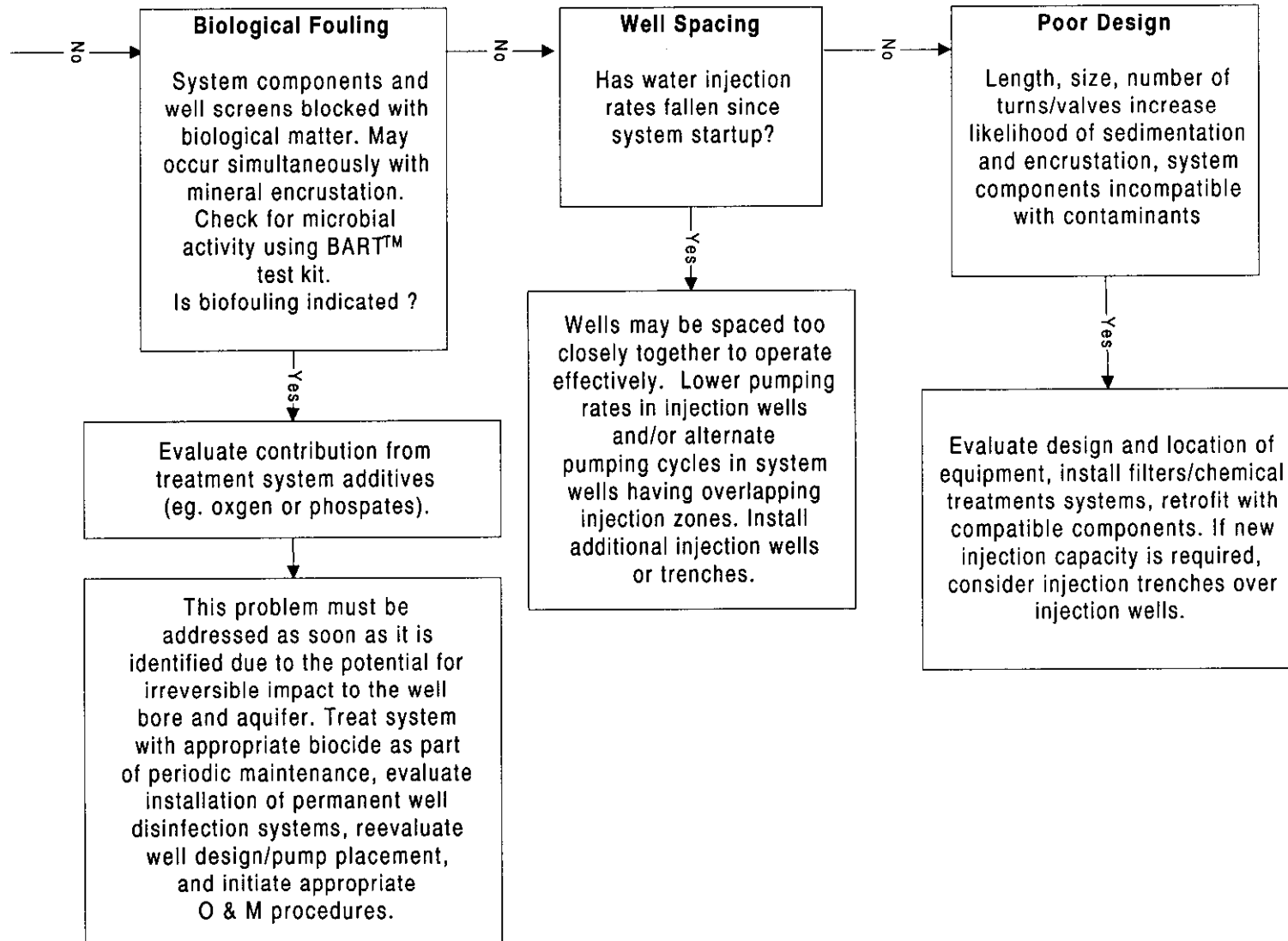

Figure 2-9
Injection Unit Troubleshooting
Injection Altering Plume Direction

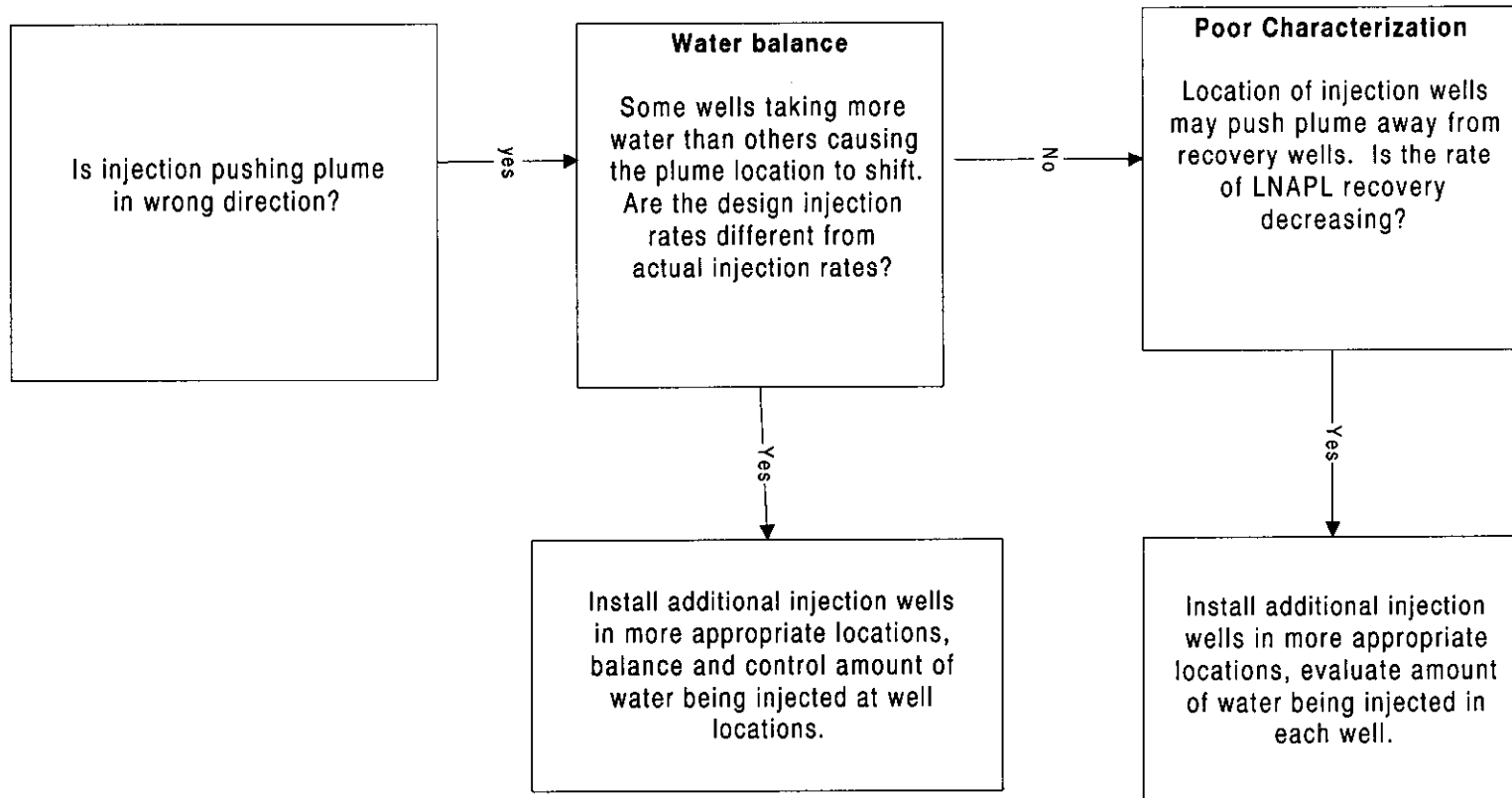

Figure 2-10
Injection Unit Troubleshooting
Mounding/Flooding
Sheet 1/2

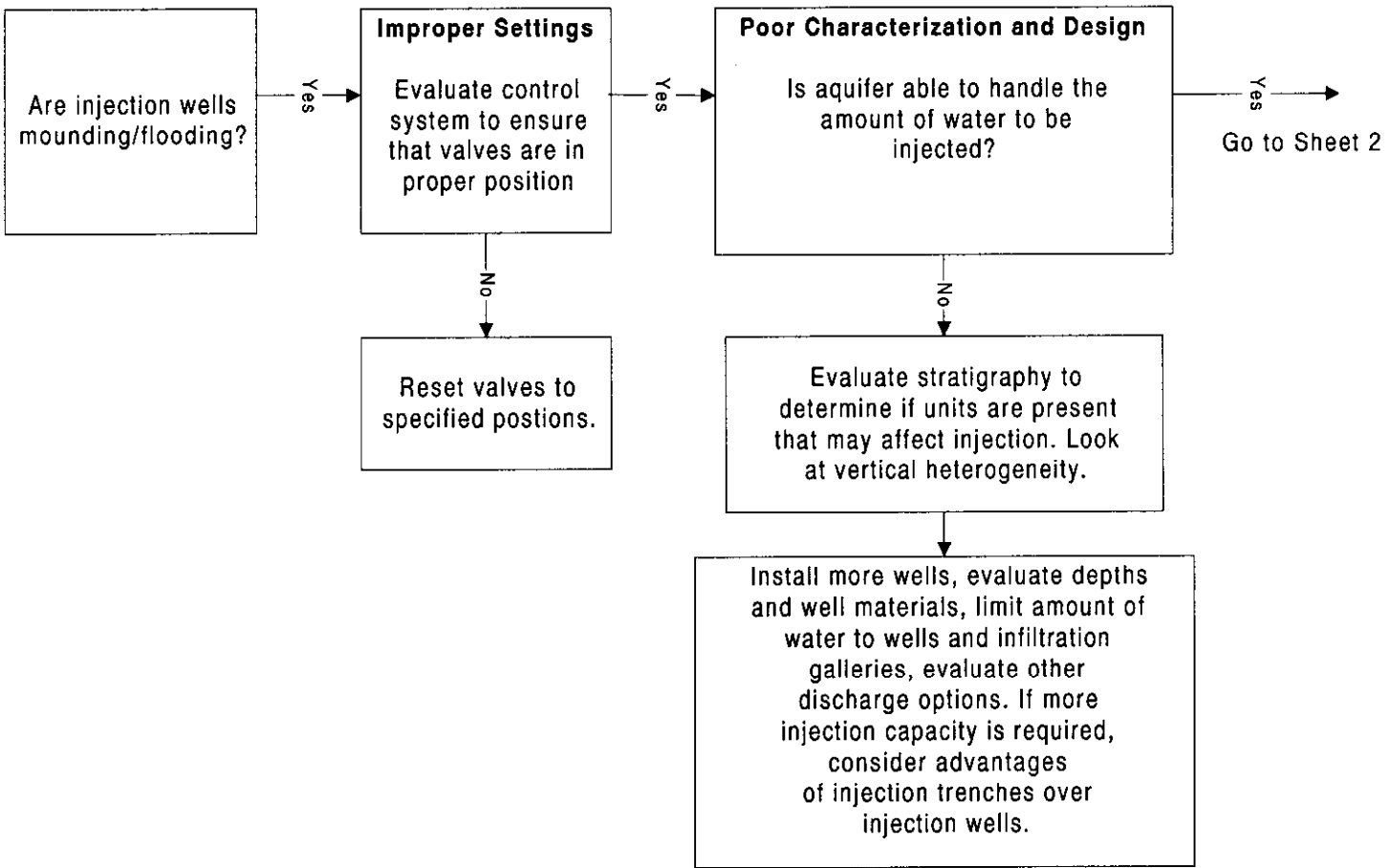
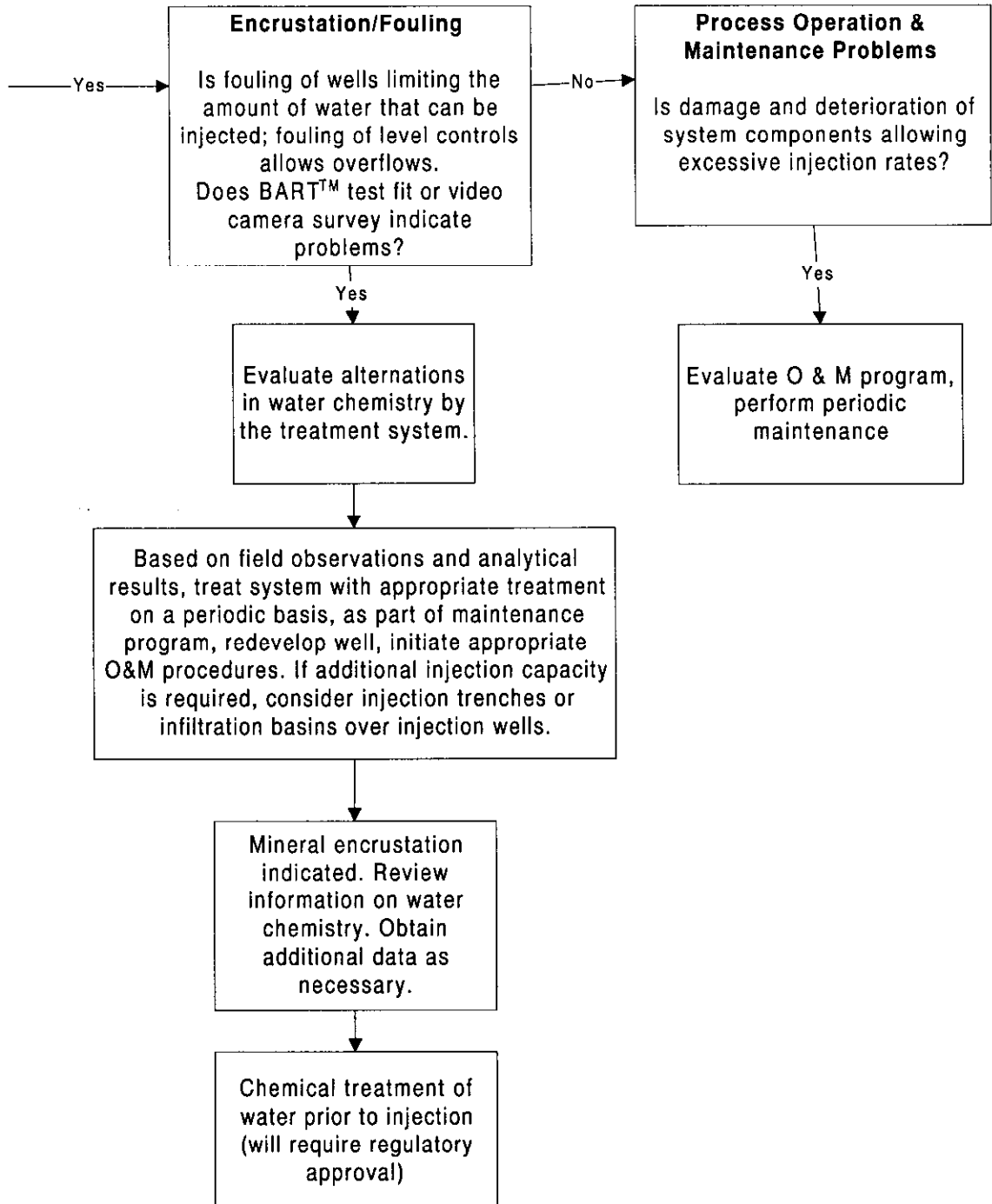

Figure 2-10
Injection Unit Troubleshooting
Mounding/Flooding
Sheet 2/2



3.0 PLANNING FOR GROUND WATER/FUEL EXTRACTION AND GROUND WATER INJECTION SYSTEM This chapter summarizes procedures and tools for use by the designer of a ground water remediation system. The core of this chapter is a series of checklists that identify data needs for the following phases:

- Remedial Investigation/Feasibility Study
- Design
- Construction
- Startup
- Operation and Maintenance

Each checklist asks the question "Will I need the following information at [phase]," then provides a comprehensive list of possible information and data the designer or others will need in order to proceed to that phase. Like the "trouble-shooting" tables in Chapter 2, this chapter describes the elements of each checklist. This chapter also includes a chart of key system components to assist the designer in the avoidance of many of the common system problems presented in Chapter 2 (see Table 3-1 located at the end of Chapter 3).

3.1 Remedial Investigation/Feasibility Study Gathering information during the site investigation phase is critical to proper completion of a project. The remedial investigation and feasibility study should have clear data quality objectives that govern the collection of data discussed in the following sections. All sources of geologic/ hydrogeologic information should be queried prior to beginning this site investigation phase (USEPA 540/G-89/004 (OSWER Directive 9355.3-06), 1988; ASTM D5730).

3.1.1 Site Conditions General site conditions, geological and hydrogeologic conditions will be discussed in subsequent sections.

3.1.1.1 Topography Topographic features are used to evaluate accessibility for surface structures, and need for pumps versus gravity flow for transport units. Topography can also be a potential indicator of subsurface geological formations. Topographic data are also used to assess drainage patterns, including run-on and run-off, ponding of water, potential recharge areas and impact to lakes and streams.

3.1.1.2 Adjacent Land Use On-site activities should be assessed for their impact on surrounding receptors and/or facilities whether residential, recreational, agricultural, or industrial. Adjacent land uses can impact activities or results of activities such as hours of operation, air emissions (including dust), nuisance odors, nuisance noise, visual limitations and overall

public relations. Assessment of adjacent land use is critical for related issues such as potentially impacted ground water use (See 3.1.1.4 Well Search and 3.1.1.5 Nearby Receptors). Analysis of adjacent land uses and adjacent buildings/structures may also indicate availability of utilities. (See 3.1.1.6 Access to Utilities).

3.1.1.3 Climate Precipitation and annual temperature ranges impact the design, operation, and maintenance of the system as well as site access (see 3.1.1.1 Topography). Protection and control systems are designed specific to the local weather conditions. Examples of impacts are "freezing pipes", precipitation exceeding containment capacity, frost heaving, snow loading to roofs, flooding and erosion around critical system components.

3.1.1.4 Water Well Search A water well search is conducted to determine whether a contaminant plume has possibly impacted or is likely to impact drinking and other types of water wells. The designer must consider whether extraction or injection will have an impact on the use of those wells due to drawdown or hydraulic mounding. A thorough search on other draws from the system should include other remediation projects or large extractions for agricultural industrial use. Water rights to the formation should also be determined at this time.

3.1.1.5 Nearby Receptors Analysis of nearby receptors is used during the RI to determine appropriate remedial criteria and points of compliance. In addition, collected information is used to determine appropriate safety measures and contingency plans for remedial systems. (See 3.1.1.4 Well Search and 3.1.1.2 Adjacent Land Use). A contingency plan should be developed which specifies actions to be taken when controls fail or monitored criteria are exceeded.

3.1.1.6 Access to Utilities (Water, Gas, Electric, Sewer Transportation) Utility access should be considered so that provisions for tie-in to the site can be planned. In addition, the locations of underground and overhead utilities must be determined for the safety of investigators and construction workers. Permitting issues for water and sewer access should also be considered.

3.1.1.7 Site Drainage Conditions Site drainage conditions determine the requirements for run-on and run-off protection (berming, grading, filling, diversion structures, etc.), containment structures for potential spillage, siltation and erosion protection. Impacts of flooding on access and operations must also be considered. Infiltration rates/recharge rates from surface water to ground water can be assessed by analysis of site drainage conditions.

3.1.2 Contamination Sources and Type Characterization The accurate and complete characterization of the type and source of contamination at the subject site is critical to the effective design of any groundwater extraction/injection system.

3.1.2.1 Source of Contamination Information on the source of contamination is used to evaluate the nature of the contaminants, the estimated release volume, potential for continuing contributions, the time of the initial release, and the rate of plume movement. This information also may indicate the potential for LNAPL. It is important to identify all contamination which may affect system operation, not just the primary contaminants of concern.

3.1.2.2 Age of Contamination The age of the contamination is used to estimate the contaminant mass/volume, potential for free-phase, and weathering/ degradation of the release. These data can be indications of the potential for intrinsic remediation (natural attenuation).

3.1.2.3 Distribution of Contamination The distribution of contaminants is used to estimate the types and extent (present and future) of dissolved ground water standard exceedances, and to estimate the volumes and extent (present and future) of LNAPL (if any). Detailed guidance for performing this task is provided in Farr et al., 1990 and Parker et al., 1990.

Information on the type and extent of soil contamination can be used to plan health and safety procedures for on-site workers. Comparison of data from vadose zone soils and saturated zone soils can be used to estimate leachability of compounds and measurement of physical/chemical/biological/toxicological properties. These data are also used in fate and transport models to compare performance of remedial alternatives during the FS and to estimate the need for complementary treatment (such as excavation and disposal, infiltration, etc.); and long-term needs for amendments (nutrients, oxygen or equivalent, surfactant, etc.).

3.1.3 Hydrogeology/Soil Characterization Accurate characterization of site hydrogeology and soil characteristics is an essential step in the process of effective system design. Incomplete information about site hydrology can result in improperly designed systems.

3.1.3.1 Soil Type/Description Information on soil type is used to identify water bearing zones and confining layers and to estimate porosities and permeabilities. Soil type information is also used to evaluate trench slope stability. The most common method for soil classification is the Unified Soil Classification System (USCS), which includes both a field classification procedure (ASTM D2488) and a laboratory classification procedure

(ASTM D2487). These procedures ensure consistency of soil classification and soil characterization.

3.1.3.2 Stratigraphy Stratigraphic data are used to map the horizontal and vertical distribution of water-bearing zones, aquitards and confining layers through correlation between borings and wells. Stratigraphic correlations are used in concert with knowledge of depositional environments (lacustrine, alluvial, saprolitic, glacial, tidal etc.) to determine lateral continuities of transmissive and confining units. The degree of discontinuity and amount of vertical layering influence wells and trench design. For example, flood plain deposits containing thin, discontinuous lenses of silty sand within clays would likely be more amenable to installation of extraction trenches than wells.

Confining layer data are used to evaluate the depth and screen location for wells set into confined aquifers or to avoid breaching of confining layers to protect clean aquifers.

3.1.3.3 Depth to Water/Seasonal and Fluctuations These data are used to determine appropriate well depths, screen lengths, contaminant smear zones and impact of fluctuations on recoverable LNAPL volumes.

Short term (days and weeks) water level fluctuation data are used to define operating procedures. Long term (months and years) water level fluctuation data are used to ensure that upward or downward water level trends are accounted for in screen placement.

3.1.3.4 Total Porosity Porosity is the unitless ratio of void space to total soil volume which is used to estimate the potential water or free-phase holding capacity of the rock or soil. Effective porosity is used to estimate the interconnected holding capacity (void space) of the soil or rock. Total porosity is calculated from bulk dry density (Danielson and Sutherland, 1986) or measured directly (ASTM D4404-84).

3.1.3.5 Specific Yield (Effective Porosity) Specific yield is a measure of the interconnected soil porosity from which water will drain under gravity. Specific yield is used in contaminant transport calculations and in models to estimate cleanup times Hall et al., 1991. Specific yield is also used in calculations to estimate the total amount of recoverable LNAPL (Farr et al., 1990; Kaluarachchi, 1989 & 1990; Parker, 1990. This parameter is rarely measured directly, but is estimated from grain size (Driscoll, 1986; Todd, 1980; and Helweg et al.; 1983) or from comparison of soil moisture measurements and total porosity measurements from above the capillary fringe (but below the root zone). Specific yield is closely related to storage coefficient and storativity which are used to estimate the length of time for

steady state conditions to be established after extraction/injection commences (McDonald & Harbaugh, 1988).

3.1.3.6 Grain Size Grain size distribution measurements are used to estimate effective porosity and permeability of the soil and rock. In addition, these measurements are used to design appropriate filter pack gradation and screen slot sizes for recovery wells. Grain size distributions are typically measured using procedures defined in ASTM D422 and ASTM D1140.

3.1.3.7 Bulk Dry Density Bulk dry density is the ratio of dry soil mass to soil volume. Bulk dry density is used to estimate total porosity and is used in contaminant transport calculations. Bulk density is measured using procedures defined in ASTM D4564.

3.1.3.8 Buffering Capacity Information on buffering capacity is used to assess the soil/ground water pH stability and resistance to applications of more basic or acidic amendments or to processes (e.g. bioremediation) which generate acidity or alkalinity. Buffering capacity is used to assess the potential to address scaling, water hardness and related issues by pH control or modification. It is an indicator of pH-dependent incompatibility reactions during applications of amendments to enhance ground water extraction, injection, or treatment in-situ or ex-situ. Reference Hem (1983) and Drever (1982) provide information on measurement and interpretation of buffering capacity.

3.1.3.9 Hydraulic Conductivity (Permeability Coefficient) Hydraulic conductivity is used to estimate contaminant migration rates and the sustainable extraction/injection rates of wells. Hydraulic conductivity can be measured using laboratory permeability (ASTM D2434), aquifer slug tests (Bouwer and Rice, 1976), and aquifer pumping tests (Driscoll, 1986; Kruseman, 1990; Walton, 1988). In general, pumping tests provide the most reliable data for design of extraction systems.

3.1.3.10 Thickness of Capillary Fringe The capillary fringe is a zone of relatively saturated soil above the water table caused by upward draw of water into pore spaces by air-water surface tension and molecular attraction (forces of adhesion) between water and soil. The vertical thickness of the capillary fringe can range from centimeters (coarse grained soils) to over 3 m thick (fine grained soils). LNAPL typically perches on the upper portion of the capillary fringe. Even within the zone of greatest LNAPL saturation, some fraction of the pores may be occupied by water. The finer the soil texture, the greater the water content and the lower the LNAPL content will tend to be. Therefore, LNAPL thickness measurements from monitoring wells must be corrected so that the actual volume of LNAPL is not overestimated (Parker and Lenhard, 1990; Farr et al. 1990; USEPA/510/R-96/001).

3.1.3.11 Microbial Assays Microbial assays, such as BART™ test kits, are used to inexpensively determine if significant populations of microbes are present. Findings can be used to plan enhanced in-situ bioremediation and to estimate if biofouling may occur. Assay results, combined with review of chemical analyses, can provide a general indicator of favorable conditions for microbes and identify whether microbes are aerobic or anaerobic.

3.1.3.12 Organic Carbon Content Natural organic carbon content (mass of carbon per mass of soil) is used to estimate the amount of contaminant sorption into soils/aquifer material and is integral to estimating remedial times. The method for measurement of total organic carbon is ASTM D2974.

3.1.3.13 Ground Water Flow Direction/Velocity Ground water flow estimates are used to estimate when initial release(s) occurred, how far the plume(s) has traveled, and the direction that the plume(s) has traveled. This information is used to position interceptor wells, trenches and monitoring wells. Flow direction and velocity are calculated using measured hydraulic gradients, hydraulic conductivities and effective porosities (Freeze and Cherry, 1979). It is important to base flow estimates on several rounds of water level measurements collected during each season of the year so that mean/net directions and rates of flow can be estimated.

3.1.3.14 Ground Water Recharge Area Natural ground water recharge occurs when the amount of precipitation exceeds the amount of run off, evaporation or vegetation transpiration. The percentage of total precipitation which infiltrates to ground water varies widely depending on soil types, amount of soil compaction, vegetation coverage, amount of paving, slope of the ground surface and depth to the water table. The software program HELP (USEPA 600/R-04/168a, 1994) is commonly used to aid in estimation of average annual recharge. Average annual recharge is used in calculations to estimate contaminant leaching from soils and in ground water models to aid in prediction of sustainable ground water extraction rates.

Identification of preferential recharge areas is important because they may locally cause higher ground water production rates, increased leaching or unusual ground water flow patterns which impact well/trench placement. Some of the more common reasons for preferential recharge are as follows:

- leakage from ponds, lakes, sewers, sumps and process areas;
- lawn and crop irrigation systems;

- localized soils with higher than average hydraulic conductivities (e.g. construction fill);
- contaminated areas where there is a lack of vegetation; and
- areas with disturbed soil or surficial depressions with reduce evaporation or run off.

3.1.3.15 Partitioning Coefficients The soil/water partitioning coefficient (volume per mass) is the concentration of a compound sorbed to soil divided by the dissolved concentration of the compound in ground water within the soil pore space (and at equilibrium). This parameter is a measure of the mobility of a compound in ground water. Compounds with coefficients that are orders of magnitude larger than 1 are essentially immobile (Freeze and Cherry, 1979). Soil/water partitioning coefficients which are used to calculate total contaminant masses from water concentration data are used in models to predict remedial times and used to estimate which compounds will take the longest to extract.

3.1.3.16 Site-Specific Geologic Conditions and Subsidence Potential Subsidence is sometimes caused by systems which extract water from silty/clayey formations (which undergo subsequent consolidation), and which dewater formations containing cavernous voids such as limestone karst terrain. In addition, subsidence can occur in the vicinities of wells which are improperly screened and generate large quantities of formation material.

Subsidence can cause differential settling of foundation structures, rupture of subgrade piping, evolution of sinkholes and (in the case of karst terrain) catastrophic collapse. If investigations reveal the potential for these events to occur, design is usually expanded to include maximum allowable dewatering, minimum distances between extraction wells and structures, and periodic subsidence detection surveys.

Design of appropriate well placements, arrays, depths, screen lengths and intervals, method of ground water extraction and injection, etc. must consider site-specific geologic conditions. Analysis of these conditions is used to assess, design, and develop appropriate controls and engineering for the construction of facilities such as tanks, piping (surface and/or buried) control rooms, office facilities, and other structures that may be subject to failure(s) due to tectonic faults, growth faults, and soil and bedrock geotechnical properties (expansiveness, karst structures, subsidence etc.).

3.1.4 Ground Water Characterization Ground water should be characterized as completely as possible to facilitate effective design for extraction, treatment and injection. The following

sections describe ground water analysis that should be performed prior to well design.

3.1.4.1 Cation/Anion (Ground Water Chemistry) Purposes of testing for cations and anions include: to assess the potential for precipitation of solids; to assess the potential for corrosion; to assess to extent to which natural attenuation is occurring; to support the evaluation of in-situ, and ex-situ treatment processes; and to determine compliance with discharge criteria, and injection criteria. Dissolved iron and manganese are the most troublesome metals commonly encountered. The most frequently used analytical list for cation/anion is as follows:

CATION		
Ammonia (NH ₄ ⁺¹)	Copper (Cu ⁺²)	Potassium (K ⁺¹)
Aluminum (Al ⁺³)	Iron (Fe ⁺² , Fe ⁺³)	Selenium (Se ⁺⁴)
Barium (Ba ⁺²)	Lead (Pb ⁺²)	Silver (Ag ⁺¹)
Calcium (Ca ⁺²)	Magnesium (Mg ⁺²)	Sodium (Na ⁺¹)
Chromium (Cr ⁺⁶ , CR ⁺³)	Manganese (Mn ⁺²)	Zinc (Zn ⁺²)

ANION	
Bicarbonate (HCO ₃ ⁻¹)	Nitrate (NO ₃ ⁻¹)
Carbonate (CO ₃ ⁻²)	Nitrite (NO ₂ ⁻¹)
Chloride (Cl ⁻¹)	Phosphate (ortho-PO ₄ ⁻³) and total (PO ₄ ⁻³)
Fluoride (F ⁻¹)	Sulfate (SO ₄ ⁻²)

GENERAL PARAMETER (Used as checks for the above Parameters)		
pH	hardness	alkalinity

The principal cationic elements (the positively charges ions present in ground water) are calcium (Ca²⁺), magnesium (Mg²⁺) and sodium (Na⁺), while the principal anionic elements (the negatively charged ions present in ground water) are alkalinity, chloride (Cl⁻) and sulfate (SO₄²⁻). Alkalinity is the measure of the acid-neutralizing capability in water and is primarily a function of the carbonate (CO₃²⁻), bicarbonate (HCO₃⁻), and hydroxide (OH⁻) content of the water. Other components such as

borates, phosphates, silicates and other bases also contribute to alkalinity.

The anion and cation content of ground water can be determined using the analyses listed in Table 3-1. Table 3-2 presents information regarding the interpretation of ground water data. The results for the individual anions, when expressed as milliequivalents per liter (meq/L), are summed to produce an anion sum. The results of the individual cations (meq/L) can also be summed to produce a cation sum. These sums should theoretically equal each other in potable water. The ion balance serves as a quick check on the accuracy of the individual analyses. The ion balance, based on a percentage difference, is defined as follows:

$$\% \text{ Difference} = \frac{100 (\Sigma \text{ cations} - \Sigma \text{ anions})}{(\Sigma \text{ cations} + \Sigma \text{ anions})}$$

As the anion concentration increases, the criteria for acceptance area as follows:

<u>Anion Sum (meq/L)</u>	<u>Acceptable % Difference</u>
0 - 3.0	±0.2 meq/L
3.0 - 10.0	±2%
10.0 - 80.0	±5 - 10%

Reference: Standard Methods for the Examination of Water and Wastewater, 20th Edition, Page 1-12.

Other anions, such as fluoride (F⁻), nitrate (NO₃⁻) and nitrite (NO₂⁻), and other cations, such as iron (Fe²⁺) and manganese (Mn²⁺), may also contribute to the ion balance. If the cation/anion balance is not within the acceptance criteria above, analyses for these additional anions and cations should be performed.

TABLE 3-1

GENERAL ANALYTICAL METHODS
FOR CATION-ANION BALANCE

ANALYSIS	METHOD ⁽¹⁾
Alkalinity	SM 2320B
Aluminum	SM 3500-Al
Ammonia	SM 4500-NH ₃
Barium	SM 3500-Ba
Bicarbonate	SM 2320B
Calcium ^a	SM 3500-Ca
Carbonate	SM 2320B
Chloride	SM 4500-Cl ⁻
Chromium	SM 3500-Cr
Copper	SM 3500-Cu
Fluoride	SM 4500-F ⁻
Hardness	SM 2340C
Iron	SM 3500-Fe
Lead	SM 3500-Pb
Magnesium ^a	SM 3500-Mg
Manganese	SM 3500-Mn
Nitrate	SM 4500-NO ₃ ⁻
Nitrite	SM 4500-NO ₂ ⁻
pH	SM 4500-H ⁺
Phosphate	SM 4500-P
Potassium	SM 3500-K
Selenium	SM 3500-Se
Silver	SM 3500-Ag
Sodium	SM 3500-Na
Sulfate	SM 4500-SO ₄ ²⁻
Zinc	SM 3500-Zn

^a - Calcium and magnesium can be measured as hardness using SM 2340C. The measurement of the individual ions is more accurate.

SM - Standard Methods for the Examination of Water and Wastewater, 20th Edition.

⁽¹⁾ It is the responsibility of the reader to identify the specific analytical methods to be used to collect the project required data.

TABLE 3-2

INTERPRETATION OF CHEMICAL WATER ANALYSES
AND ANALYTICAL METHODS

ANALYSIS	INTERPRETATION	ANALYTICAL METHOD
Alkalinity	Indicates the presence of carbonates, bicarbonates, and hydroxides. Calcium and magnesium carbonates will cause chemical encrustation of wells.	SM 2320
Calcium ^a	Dissolves from soil and rock, especially limestone, dolomite and gypsum formations. Along with magnesium, calcium is the source of most of the hardness and scale formation properties of water.	SM 3500-Ca
Chloride	Dissolves from rock and soil. High concentrations increase the corrosiveness of water.	SM 4500-Cl
Iron	Dissolves from rock and soil. If aggressive water (pH below 7) is present, iron will dissolve from pipes and pumps. On exposure to air, iron in ground water oxidizes to a reddish-brown precipitate. Concentrations exceeding 0.3 mg/L can favor the growth of iron-reducing bacteria that can stimulate stainless steel corrosion. Elevated concentrations in groundwater are indicative of biofouling.	SM 3500-Fe
Magnesium ^a	Dissolves from soil and rock, especially limestone, dolomite and gypsum formations. Along with calcium, magnesium is the source of most of the hardness and scale formation properties of water.	SM 3500-Mg
Manganese	Dissolves from shale, sandstone or alluvial material. Elevated concentrations in pumped ground water are indicative of biofouling.	SM 3500-Mn
Nitrate	Source is decaying organic matter, sewage and fertilizers. Concentrations exceeding background may suggest pollution. Nitrate encourages the growth of algae and other organisms which may contribute to biofouling.	SM 4500-NO ₃
Nitrite	Nitrite is an intermediate in the nitrogen cycle, both in the oxidation of ammonia to nitrate and in the reduction of nitrate. Excessive concentrations in groundwater are indicative of a nitrate or ammonia source.	SM 4500-NO ₂
Sulfate	Dissolves from rock and soil containing gypsum, iron sulfides and other sulfur compounds. Commonly present in industrial wastes. Sulfate in combination with calcium can form scale. Concentrations exceeding background may indicate sulfur biofouling from the oxidation of sulfides. In anaerobic systems, sulfate reducing-bacteria will utilize molecular hydrogen and produce sulfide. Sulfides are a cause of electrochemical corrosion.	SM 4500-SO ₄ ²⁻
^a - Calcium and magnesium can be measured as hardness using SM 2340C. The measurement of the individual ions is more accurate. SM - Standard Methods for the Examination of Water and Wastewater, 20 th Edition.		

It should be noted that these analyses are typically performed on filtered samples (0.45 micron filter) so that dissolved geochemistry can be understood. Regulatory agencies, however, may require that these analyses be performed on unfiltered samples. In that event, both filtered and unfiltered samples should be obtained for analysis.

Alternate electron acceptors, some of which are cation or anion, are important parameters for the evaluation of natural attenuation of hydrocarbon contaminants in ground water. These include NO^{-2} and SO^{-4} (Wiedemeier et al. 1995; Wiedemeier et al. 1996).

3.1.4.2 Total Dissolved Solids (SM 2540C) Total dissolved solids (TDS) analyses are used (in combination with ion analyses) to determine water hardness; the potential for scaling in extraction, treatment and injection systems; the potential for incompatibility with in-situ and ex-situ amendments to the systems; and the dissolved organic content of the water (as Total Volatile Dissolved Solids).

3.1.4.3 Total Suspended Solids (SM 2540D) Total suspended solids (TSS) analyses are used to determine if suspended solids should be removed prior to treatment and/or injection to prevent equipment plugging or fouling, and to prevent injection well slot or formation plugging. TSS data collected in monitoring wells may not be indicative of TSS levels in production wells due to differences in filter pack design, screen design, and high entrance velocities in production wells.

3.1.4.4 Total Organic Carbon (SM 5310) Total organic carbon analyses determine the total organic content of water including compounds or materials not specifically analyzed. These analyses indicate the potential total burden of organics to be treated by any non-specific in-situ and/or ex-situ treatment system.

Dissolved organic carbon (DOC) is obtained from the analysis of filtrates of groundwater samples. Samples should be filtered in the field prior to acidification. Samples are filtered through a 0.45 μm filter, acidified to a pH less than 2, and then analyzed using the same techniques as a total organic carbon (TOC) sample.

3.1.4.5 pH (SM 4500H or Field Method) pH analyses are used to assess the need to adjust the extracted/injected ground water pH for in-situ and/or ex-situ treatment systems, assess the need for corrosion protection and specific materials of construction, and assess the compatibility of the water with pH sensitive or reactive amendments. This parameter is usually measured in the field. Buffering capacity of ground water should be measured in order to allow for proper plant design.

3.1.4.6 Oxidation-Reduction Potential (ORP) (Field Method) The ORP is used to measure the oxidation state of ground water that results from the geochemistry of the ground water. The analysis is used to determine requirements for providing electron acceptors (e.g. oxygen, nitrate, etc.) and to estimate incompatibility reactions of amendments due to the ORP (e.g. metal sulfide precipitates). ORP is also used to select materials of construction and operational controls to prevent corrosion, control odors, and reduce potential safety hazards (e.g. hydrogen sulfide). This parameter is usually measured in the field.

3.1.4.7 Microbial Assay Microbial assays, such as BART™ Test Kits, are used to inexpensively determine if significant populations of microbes are present. Findings can be used to plan enhanced in-situ bioremediation and to estimate if biofouling may occur. Assay results, combined with review of chemical analyses, can provide a general indicator of favorable conditions for microbes and identify whether microbes are aerobic or anaerobic (USEPA 600/K-93/002, 1993).

3.1.4.8 Toxicity Tests Toxicity tests are indicators of ground water toxicity to microbes for treatment design. Tests such as Microtox 7 indicate the collective toxicity for microbes.

3.1.4.9 Conductivity (Field Method) Conductivity correlates with the general hardness, dissolved solids content, and specific cation/anion content. This parameter is typically measured in the field. Highly conductive environments may require the need for galvanic protection for steel wells or the use of PVC wells.

3.1.4.10 Dissolved Oxygen (Field Method) Dissolved oxygen (DO) is an indicator used to evaluate intrinsic bioremediation and the potential for enhancing in-situ bioremediation. DO indicates whether oxygen is available as an electron acceptor. Conditions are usually considered aerobic if the DO is greater than 2 mg/L, and anaerobic if the DO is less than 0.5 mg/L. DO measurements are used in conjunction with concentrations of ionic species to evaluate the potential for well encrustation. DO measurements should be made using an in-line system with a probe or in-situ to minimize influence of atmospheric oxygen.

3.1.4.11 Hardness as Calcium Carbonate SM 2340C) Hardness as calcium carbonate is used as a generalized assessment of the potential for scaling, treatment process and microbial toxicity, and associated hard water problems. Hard water conditions may lead to well encrustation and declining production rates.

3.1.5 LNAPL Characterization The presence and extent of LNAPL must be understood in order for it to be remediated as a continuing source to the dissolved contaminant plume. References provide guidance for LNAPL characterization are as follows: API

(American Petroleum Institute) Publ. 4474, 1988, API Publ. 1628, 1989, Cohen et al., 1992, USEPA 600/R-92/247, 1992, USEPA 540/S-95/500, 1995, USEPA 510/R-96/001, 1996, USEPA OSWER Directive 9283.1-06, 1992.

3.1.5.1 LNAPL Source Information on the source of LNAPL is used to estimate the time of release, LNAPL constituents, and phase separation potential.

3.1.5.2 LNAPL Density (or Specific Gravity) Density is used to differentiate the potential for a sinking phase (DNAPL) and a floating phase (LNAPL). In addition, density measurements are used to correct water levels measured from wells which contain LNAPL (Parker and Lennard, 1990).

3.1.5.3 LNAPL Viscosity Viscosity is used to estimate the ability to move the free phase through the soil matrix to the recovery point/trench/well and pump or otherwise recover the free phase to the surface (ASTM D445).

3.1.5.4 LNAPL Solubility LNAPL solubility measurements (mass per volume) are compared to ground water concentration data to estimate the vertical and lateral extent of LNAPL between wells which contain LNAPL and those which do not. In addition, solubility measurements can be used to estimate the total volume of original LNAPL spillage. Finally, solubilities of individual compounds (Montgomery and Welkom, 1990; Leinonen and Makay, 1973) are used to estimate the relative concentrations of constituents in the ground water contaminant plume from a mixed, multi-component NAPL.

3.1.5.5 LNAPL Water Interfacial Tension (Surface Tension) Surface tension is used to estimate the LNAPL affinity for the soils/rock interstices and to estimate the extent of LNAPL ganglia formation for a given soil porosity, grain size, organic carbon content, etc. It also is used to select the appropriate surfactant(s) and other physical/chemical agents for enhanced recovery of the LNAPL (Boyd and Farley, 1992; Demond and Roberts, 1991; Feenstra et al., 1991). A related measurement is capillary pressure saturation characteristic (see Paragraph 3.2.3.10).

3.1.5.6 Areal Extent of LNAPL Site characterization for design of LNAPL recovery systems must include measurement/estimation of the vertical/lateral extent of free flowing LNAPL and residual LNAPL droplets. The extent of residual LNAPL is controlled by the physical properties of LNAPL and soil, the rate of migration and seasonal water table fluctuations which smear LNAPL above and below the water table. Distinguishing between mobile and residual LNAPL influences performance expectations, well placement, pump specifications, pumping strategies and screened intervals.

Areal extent is estimated from LNAPL thickness measurements (corrected for capillary fringe effects) and comparison of detected concentrations to aqueous solubilities (Evans and Thompson, 1986; Parker and Lenhard, 1990; Mercer and Cohen, 1990). The calculations use the parameters discussed in previous sections.

A small percentage of LNAPL is also sorbed to soil organic carbon. While the total mass of this sorbed LNAPL is usually small, it is important because it results in a complete exhaustion of the soils ability to sorb and retard the migration of dissolved contaminants.

3.1.5.7 Rate of LNAPL Movement Estimates of LNAPL migration rates (length per time) prior to startup are used to calibrate models which estimate LNAPL recovery rates. Migration rate estimates are also used to determine if remedial systems should be installed on a fast-track basis. LNAPL which is found to spread quickly towards water supply wells may warrant fast-track installation of interim systems until full scale systems can be brought on line.

LNAPL migration rates can be empirically observed by documenting dissolved concentration and LNAPL thickness trends in monitoring wells. Alternately (where monitoring data is lacking), migration rates can be estimated by calculation/models which incorporate the parameters discussed in previous sections (Abdul, 1988; Faust et al., 1989; Kaluarachchi and Parker, 1990).

3.1.5.8 Apparent LNAPL Thickness Apparent LNAPL thickness measured in a well is used (after correcting for capillary fringe effects) to estimate the volume and mass of LNAPL and to guide the selection of pump systems. (USEPA 540/S-95/500, 1995 and USEPA 510/R-96/001, 1996). LNAPL volume estimates cannot be inferred directly from well LNAPL thickness data without consideration of soil and NAPL properties, and may lead to over design of the extraction system. This is because of LNAPL accumulation above the capillary fringe, water level depression in the well, fluctuations in fluid levels (which trap NAPL below the water table during high water periods and immobilize NAPL in the vadose zone during low water periods), and impacts of well filter pack grain size distributions. Taken together, these and other factors result in a finding that the actual thickness of NAPL in the formation cannot be calculated from well fluid level measurements alone.

3.1.5.9 Effects of Soil Properties on LNAPL Thickness At a site where LNAPL such as gasoline or diesel fuel is present, these are typically observed in wells screened across the water table and capillary fringe. All too often, however, LNAPL is viewed as occupying an oil-saturated "pancake" in the surrounding formation, the thickness of which is misconstrued as being linearly related to the thickness of the measurable LNAPL in the well. Although LNAPL reveals itself as a discrete oil lens

floating on the water in a well, it does not occupy a distinct layer of constant S_0 floating on the top of the capillary fringe in the surrounding soil. This can lead to inappropriate system design.

Procedures for estimating actual LNAPL thickness are detailed in Parker and Lenhard (1990) and Farr et al. (1990).

3.1.6 Regulatory Issues/Permits The regulatory issues and required permits should be identified at the onset of the design process. Regulatory requirements can and do affect system design and implementation. Proper coordination with the regulatory agencies will expedite the design and implementation of systems.

3.1.6.1 Lead Regulatory Agency In most instances, a Federal or state regulatory agency will be involved to consult upon, oversee or maybe approve investigative and remediation activities. Early, open, and continued coordination with the lead regulatory agency is important to the development of realistic, protective cleanup goals as well as establishing criteria for compliance/long term monitoring.

3.1.6.2 Other Government Agency Involvement Other agencies, such as Federal/state landowners, resource agencies (such as the U.S. Fish and Wildlife Service or state equivalent), and local government entities may have an interest in the cleanup goals. At appropriate phases of the project, these agencies should be informed of project activities and given the opportunity to comment on response plans.

3.1.6.3 Permits Federal, state, and local permits may in some cases be required for investigative activities and implementation of remedial actions. Air emissions, well construction, soil disturbance, and utility hook-ups are examples of activities or resulting impacts that could require permits (see Section 1.4.2). Additionally, permits may be required for treatment/disposal activities. The lead time required to submit documentation and obtain permits should be specified in a time line developed during the design phase.

Agency counsel should be consulted to establish requirements for specific agency projects.

3.1.7 Feasibility Study Objectives of the Feasibility Study are as follows:

- develop a list of applicable remedial alternatives;
- compare, choose and conceptually specify the most appropriate combination of extraction transport, treatment and injection (if applicable) techniques;

- collect supplemental data to support the detailed design phase; such as treatability studies and pumping tests
- refine remediation goals as appropriate using collected data; and
- evaluate all alternatives applying the CERCLA remedy selection criteria.

The following sections summarize the steps to achieve these objectives. Documents which provide detailed guidance are as follows: Committee on Ground Water Cleanup Alternatives, 1994, USEPA 600/2-90/011, 1990, USEPA 600/8-90/003, 1990, USEPA 600/2-90/027, 1990, Satkin and Bedient, 1988, USEPA 540/R-92/071a, 1992, USEPA 625/6-85/006, 1985, USEPA 430/9-78/009, 1978, Driscoll, USEPA OSWER Directive 9355.4-03, 1989, USEPA 540/G-87/004, 1987, Zheng et al., 1991.

3.1.7.1 Design Basis The design basis is a succinct set of assumptions which define the area to be remediated, compounds to be treated and cleanup criteria. The design basis should include clear objectives with regard to system performance (e.g., is the system designed to capture entire plume, remediate high concentration areas, or to meet other performance criteria?). It should be noted that the construction and startup phases include comparison of actual conditions to assumed conditions and a feedback loop to the design team to determine if design or operating modifications are warranted. The design basis should consider the operation of individual wells, as well as grouped wells over the life of the project and how their operation affects remediation objectives.

The following design issues should be considered:

- 1) Cleanup Goals Cleanup goals are determined by regulations, modeling, client requirements, exposure risk studies and limitations of current technologies. These goals are used as the basis for system design, schedules for completion, areal limits of cleanup and cost estimates.
- 2) Plume Size/Configuration Defining the nature and extent of ground water standard exceedances defines the required areal extent of hydraulic capture. This element is typically defined on maps and cross-sections depicting the area within which dissolved concentrations must be actively remediated and the area (if any) within which LNAPL must be removed.

- 3) Soil Contamination Areal Extent It may be important to define the extent of contaminated soils or landfilled materials that may act as continuing sources of releases to the ground water. This element is typically specified on a map depicting the areal extent of soils/waste which may leach contaminants to ground water above cleanup goals.
- 4) Contaminant Mass/Volume Contaminant mass/volume is used to estimate cleanup time, performance expectations and waste management requirements. This element is typically specified in a table listing estimated masses of each compound below the water table (dissolved and sorbed) and volumes/masses of LNAPL (free flowing, residual, and sorbed).
- 5) Concentrations of Contaminants at Extraction Locations Data from the RI and modeling/calculations from the FS are used to estimate the startup concentrations of each contaminant at each extraction point and determine the rate of ground water extraction necessary to capture the plume. These estimates are used to calculate concentrations in the combined effluent so that appropriate piping materials and required treatment efficiencies can be determined. This element is typically defined in a table of concentrations by location.
- 6) Water Injection/Discharge Determining the fixed disposition of the treated ground water is a critical factor to system design. Evaluate the compatibility of treated water with proposed injection or discharge methods.
- 7) Cleanup Duration Constraints Regulatory agencies, responsible parties or third parties typically require specification of the minimum and maximum expected times of system operation. These estimates are used to estimate total project costs, required equipment durability, infrastructure requirements, permit periods, and to track performance during the operating phase. This element is usually specified in a project time line. It should be noted that project duration estimates are approximate and almost always require adjustment after system startup.

3.1.7.2 Comparison and Choice of Remedial Alternatives The objective of this task is to choose the most cost-effective remedial alternative which is protective of human health and the environment, complies with ARARs and meets agency requirements. Comparison of remedial alternatives typically proceeds in accordance with the following step-wise process:

- 1) Estimation of the minimum required configuration of each alternative to attain cleanup goals. This step typically entails use of models.

- 2) Estimation of project life for each alternative. This step typically entails use of models.
- 3) Estimation of the contaminant masses which would be removed by the minimum configuration of each alternative (to determine treatment, disposal and permitting requirements).
- 4) Estimation of permitting requirements and costs.
- 5) Estimation of capital and O&M costs including:
 - cost (present and future value) versus time plots (annual and cumulative);
 - normalized ground water extraction costs:
 - dollars/gallon of water (if applicable);
 - normalized remediation costs: dollars/pound of mass removed; and
 - uncertainty of estimates evaluation.
- 6) Comparison of technical performance and reliability. The following criteria are commonly evaluated:

Waste Management Criteria

- amount of water generated requiring treatment;
- generation of hazardous waste requiring off-site disposal;
- generation of vapor requiring treatment;

Technical Criteria

- mechanical reliability and ability to operate "hands-off";
- ability to use existing facility infrastructure and personnel;
- technological maturity and ease of implementation;
- flexibility for expansion, enhancements and adjustments;
- lateral distance of hydraulic capture (e.g. ability to capture off-site ground water);
- mass removal rates;

- ability to mobilize and remove LNAPL;
- resultant concentrations at receptors; compatibility of treated water with injection or discharge

Risk Criteria, Community Relations Criteria, and Agency Compliance Criteria

- time to come on-line and become effective;
- potential for spills;
- potential for human (e.g. worker and public) exposure to compounds handled/treated or brought to the surface;
- visual impact;
- number of components to be off-site;
- required space and potential hindrance of facility operations;
- compliance with applicable regulations; and
- air, water and waste permitting requirements, if any, and costs.

These comparisons result in preliminary choice and conceptual specification of a remedial alternative. However, bench scale or pilot testing is commonly required to confirm applicability and provide sufficient information for design.

3.1.7.3 Bench Scale and Pilot Testing This task is used to collect additional data required for engineering design. Typical work can include the following: pumping or injection tests; bench scale bio-feasibility testing to determine the appropriate ratios of nutrients/oxygen and to estimate degradation rates; bench scale treatability testing; and pilot LNAPL recovery. Do not bypass pump tests or treatability studies even in projects where design is obvious. Any money saved in not performing pilot tests/pump tests will be expended trouble-shooting an improperly designed system later in the project.

3.1.7.4 Performance Criteria (or Expectations) Cleanup goals provide the end point requirement for remedial performance. Performance criteria are the day to day operational goals which, if achieved, will result in attainment of cleanup goals. Performance criteria are developed by comparing the design basis to results of models and calculations developed during comparison of alternatives. It should be noted that the construction and

start up phases include comparison of actual conditions to assumed conditions and a feedback loop to determine if performance criteria require modification. Many systems obtain unexpected well yields and the designer needs to account for this possibility in well design. Refer to USEPA 600/R-94-123, Methods for Monitoring of Pump and Treat Performance.

1) Extent of Hydraulic Capture The hydraulic capture zone is the lateral and vertical volume of an aquifer in which there is a net inward flow of ground water towards ground water extraction points. The converse of this is the zone of hydraulic influence provided by injection points. Required capture zones and zones of injection influence are typically specified on maps and cross-sections which depict areas within which water must flow towards the extraction system and areas within which the aquifer must receive injected water. If detailed modeling has been performed, the maps will specify capture zones for individual wells in addition to the total system (defining treatment cells within the aquifer). Adherence to these criteria is evaluated during the operating phase by hydrogeologists who contour water levels measured from monitoring and extraction wells (accounting for well efficiencies) and who estimate directions of ground water flow.

The required zone of LNAPL capture is also specified for sites with mobile LNAPL. In general, the required capture zone is specified on a map as the extent of mobile LNAPL. Adherence to this criterion is evaluated during the operational phase by hydrogeologists who contour free phase thicknesses in monitoring wells (corrected for capillary fringe effects) and compare changes to the underlying zone of ground water capture.

2) Water Balance Water balance is the tabular listing of required extraction /injection rates from/to each well. The total specified extraction rate is sometimes greater than or less than the specified total injection rate. In these instances the water balance also specifies the required rates of water to be supplied from an outside source or sent to an alternate disposal location (e.g. an NPDES or POTW outfall).

Water balance is typically estimated during the FS based on pilot testing and modeling. The actual flows to and from individual wells after start up are never exactly the same as estimates. Therefore, water balance criteria include acceptable flow rate ranges for each well and the total system. In addition, the water balance typically includes specification of the maximum flow capacity for which piping and treatment systems should be designed. These separate specifications are typically 30% to 100% higher than the maximum estimated flows to account for potential future system expansions.

Operational compliance with water balance specifications is not typically measured on a day by day basis (except as applies to specific permit requirements) because estimates used to generate the specifications are typically based on long term average trends. Therefore, it is most common for water balance review, interpretation and operational adjustment to be performed on a quarterly, tri-annual or semi-annual basis taking into account seasonality of flow rates.

In some instances, water balance audits result in specification of pumping/injection schedules which vary over time (e.g. pulsed pumpage). Another example is periodic conversion from extraction to injection to remove contaminants from hydraulic stagnation points between wells.

3) Pore Volume Exchange Rate The pore volume exchange rate (pore volumes per year) is the number of complete pore volumes of water removed from the hydraulic capture zone per year. Pore volume removal rate criteria (e.g. two pore volumes/year) are developed by reviewing FS transport models to determine the amount of annual flushing required to achieve cleanup within the specified project duration (Zheng et al., 1991).

Pore volume removal rates are calculated during the operational phase by summing extracted water volumes and dividing removed volumes by the volume of water in the capture zone (calculated during the FS). It should be noted that hydrogeological interpretation of ground water levels should also be used to verify that the extracted ground water originated in the desired hydraulic capture zone.

4) Dissolved Mass Recovery Rates and Mass Balance As discussed in other sections, remedial progress is indirectly tracked by monitoring ground water extraction rates and concentration trends over time. Mass recovery rate (mass/time) is a direct measure of remedial progress which accounts for both ground water extraction rates and concentration trends. Mass removal rates are calculated by multiplying ground water extraction rates by contaminant concentrations in the removed water (with unit conversions).

Mass removal rate performance criteria are set by calculating the total mass of dissolved and sorbed contaminants in the plume (above cleanup goals) and using transport models to calculate the required annual removal rates (high in early years and low in later years) to complete remediation in the specified project duration.

Evaluation of mass recovery rates is not performed on a day by day basis (unless required by air or water discharge permits). However, mass removal rate audits should be performed at least annually. The mass balance audit should include two specific calculations: summation of mass removed based on effluent data

and estimation of mass change in the plume based on monitoring well data. These calculations can result in several findings as follows:

- If the mass removed from extraction wells is significantly less than the change in plume mass, it is possible that natural attenuation mechanisms are contributing to remediation;
- If the mass removed from extraction wells is approximately equal to the change in plume mass, the extraction system is likely performing in accordance with design; and
- If the mass removed from extraction wells is significantly greater than the change in plume mass, there may be an active source (e.g. leaching soils), previously unknown areas of LNAPL, or greater than estimated plume extent. This finding usually results in the need for additional investigation.

It should be noted that estimating the dissolved and sorbed masses of compounds in a plume requires numerous assumptions regarding extent, partitioning coefficients and equilibrium state. Therefore, these estimates must include a detailed sensitivity analyses by a qualified hydrogeologist. In some cases it is found that the degree of uncertainty associated with mass estimates is too high to allow meaningful conclusions.

5) LNAPL Recovery Rates Predictive tools for estimation of LNAPL recovery rates are not as accurate as those which are used to predict ground-water recovery rates. Therefore, the total volume of recoverable LNAPL is estimated during the RI (see Section 1.3.1) and the cumulative volume of LNAPL recovered is tracked and extrapolated to forecast total amount which is anticipated to be recovered. Operational extrapolations rarely match original estimates of recoverable LNAPL. This finding is as likely due to incomplete understanding of LNAPL extent/mobility as it is likely to be due to inadequate system performance. Another factor that may affect LNAPL recovery is that the mobility of LNAPL decreases as mass is removed. Most systems do not recover more than 50% of the mass estimated to be in place.

6) Concentration Trends The ultimate performance criterion for any remedial effort is attainment of cleanup concentrations outside the point of compliance (either by active remediation or natural attenuation).

Concentration trends are typically tracked to determine progress towards this goal. When concentrations fall below cleanup goals, systems are shut down and confirmation monitoring

is performed. However, concentrations frequently rise back above standards after system shutdown due to slow desorption of contaminants from aquifer materials or continued contributions from sources. Previously discussed mass balance audits are used to estimate the likelihood for this "rebound" to occur.

Performance criteria for concentration trends typically consist of statistical procedures used to determine if anomalous monitoring results are due to bad data, seasonal variations or long term trends. Reference USEPA 530/SW-89/026 (1989) provides detailed guidance for developing appropriate statistical protocols.

Most states recognize that ground water extraction causes concentrations to decline asymptotically towards cleanup goals and that natural attenuation mechanisms may contribute equally to remedial progress during the later stages of a project. Therefore, some systems are shut down before cleanup goals have been achieved because it has been demonstrated that natural attenuation mechanisms will be sufficient to complete remediation. Reference Wiedemeier et al. (1995) and Wiedemeier et al. (1996) provides detailed procedures to evaluate natural attenuation.

7) Amount of Drawdown Pumpage causes dewatering of water table aquifers. Because this technology removes contaminants through water flushing, remediation halts in the dewatered portions of the aquifer (potentially causing an increase in contaminant concentrations when systems are turned off). Therefore, most performance criteria include specification of maximum allowable drawdown in and near extraction wells. Maximum allowable drawdown is developed by balancing the desire for higher extraction rates (and more drawdown) against the desire for less drawdown (lower extraction rates). Maximum allowable drawdowns typically range between 5% and 30% of the saturated thickness in the vicinity of the extraction wells depending on hydraulic conductivities, dissolved contaminant distributions and the desire to minimize smearing of LNAPL.

Another important aspect in evaluating drawdown is the effect, if any, that the treatment system operation has on any other production wells in the vicinity.

Ground water pump and treat systems are typically designed to maximize ground water production. This objective may conflict with local or state ground water use rules and regulations which are designed to minimize aquifer drawdown and prevent production rate declines in existing water supply well fields. Consequently, design may require ground water modeling to estimate the impact of remediation systems on the sustainable flow rates from nearby supply wells. Similarly, agencies may require estimation of the potential impact on stream base flow in

areas where ground water discharge to surface water is a significant percentage of the total stream flow. This work may also require consumptive use permits and/or public hearings in areas with limited ground water or surface water resources.

It should be noted that the water level in an operating extraction well is lower than the water level in the adjacent aquifer due to head losses across the filter pack and well screen. This head loss can be accounted for using methods detailed in Helweg et al. (1983) and Todd (1980).

3.2 Design The RI/FS process results in the specification of cleanup goals and conceptual choice of remedial technologies. This section details the following design phase steps:

- design of extraction/injection units (Section 3.2.1);
- pump design/specification (Section 3.2.2);
- piping design (Section 3.2.3);
- treatment unit design (Section 3.2.4); and
- electrical/controls specification (Section 3.2.5).

Documents which provide guidance regarding remedial system design are as follows: API (American Petroleum Institute) Publ. 1628, 1989, Hampton and Heuvelhorst, 1990, Mercer and Cohen, 1990, Testa et al., 1992, USEPA 542/B-95/002, 1995, USEPA 570/9-75/001, 1977, U.S. Department of the Interior, Ground Water Manual, USACE EM 1110-1-502, 1994, Wisconsin Dept. of Natural Resources, PUBL-SW183-9, 1993.

3.2.1 Design of Extraction/Injection Units The basic components of an extraction well are:

- the borehole;
- the filter pack between the borehole and screen;
- the well screen;
- the well casing above screen (and often including a silt collection sump below screen);
- the bentonite seal above filter pack and below grout;
- grout in the annular space between the well casing and borehole; and
- surface and near surface manholes, concrete pads and protection devices;

- means of measuring water level.

Wells sometimes include additional components such as piping within the filter pack to facilitate treatment chemical feeds/water level measurement, multiple tiers of casing to prevent cross contamination during installation, and multiple screen intervals. The following references provide comprehensive guidance for well design and installation: Driscoll, 1986, Hampton and H.G. Heuvelhorst, 1990, Helweg et al., 1983, Smith, 1995, USEPA 570/9-75/001, 1977, ANSI/AWWA A-100-90, 1997, ANSI/ASAE EP400.1, 1989.

The following sections provide brief summaries of key well design elements.

3.2.1.1 Specification of Numbers and Locations of Wells and Trenches The numbers and locations of extraction wells and trenches are specified during the FS for cost estimating purposes. The actual physical locations of the wells are determined during design. (see Section 1.3.2).

3.2.1.2 Specification of Screen and Casing Depths Screen and casing depths are specified during the design phase. The specified depth of well screen/casing should give consideration to the following issues. If LNAPL is present, the top of screen is usually placed above the seasonal high LNAPL level to allow skimming of mobile LNAPL (without ground water pumpage, if desired). If LNAPL is not present, the depth and length of screen are controlled primarily by three issues:

- placement of screen across the interval of highest ground water contamination to maximize mass/recovery; or
- placement of screen across the interval of highest hydraulic conductivity to maximize pumping rates and extent of hydraulic capture; or
- placement of screen deep enough so that the pumping water level will not drop into the screened interval, potentially causing biofouling or geochemical encrustation.

It is common that these three criteria conflict with one another, requiring the designer to prioritize these criteria for each site. It is common practice in the water supply industry to install wells with multiple screened intervals in different formations to maximize flow rates. This practice should be used very cautiously in remediation systems because of the potential for cross-contamination of formations and geochemical interactions which can cause biological fouling and chemical encrustation. For detailed guidance on depths of casing and screened intervals refer to: Abdul, 1992, Helweg et al., 1983,

USEPA 570/9-75/001, 1977, and Wisconsin Dept. of Natural Resources, PUBL-SW183-9, 1993.

3.2.1.3 Specification of Casing Materials, Diameter, Screen Type and Filter Pack The primary considerations when choosing casing and screen materials are entrance velocity of water into the well, chemical compatibility with ground water/contaminants, cost and durability to withstand years of removing and reinstalling pumps. Steel (stainless or otherwise) casing and screen is usually preferred for long term projects and for sites with high contaminant concentrations or LNAPL. However, it should be noted that some NAPLs and highly saline waters may corrode stainless steel. USEPA 570/9-75/001, 1997 provides guidance for choice of well materials.

The primary objective in selecting well diameter, screen slot size and filter pack gradation is to maximize well efficiency. High well efficiencies (preferably above 80%) provide higher flow rates, reduce chances of encrustation and reduce wear on equipment. High well efficiencies also reduce the potential for cascading in the filter pack, reducing turbulence and entrainment of oxygen. Key approaches to achieving this goal are as follows:

- larger diameter wells and boreholes (balanced against cost);
- use of filter pack composed of washed, rounded quartz grains;
- design of filter pack and slot size in accordance with procedures defined in USEPA 570/9-75/001 (1975); choice of screen types which maximize open area (e.g. wire wrapped screens instead of machine cut slots); and
- use of screens constructed with inwardly directed "V" shaped wire (USEPA 600/4-89/034, 1989);
- The well screen and filter pack should be designed to match formation sand.

As with any construction project, local availability should be considered during specification of well materials to minimize cost and to facilitate future maintenance and repair.

3.2.1.4 Specification of Drilling Procedures Drilling methods should be specified that are appropriate, efficient and maximize post-construction well efficiency. Common drilling techniques include hollow stem auger drilling, mud rotary drilling and air rotary/percussion drilling (for rock). Hollow stem auger drilling is commonly used during the RI/FS because it allows precise soil sample collection. However, this drilling method causes significant smearing of clays causing inefficient wells which are

difficult to develop. Mud rotary drilling can be used to greater depths than hollow stem auger drilling with less formation damage. However, mud rotary drilling (and subsequent development to remove drilling fluids system) can generate significant volumes of mud and water which can be expensive to dispose of. In addition, drilling fluids should be carefully chosen to ensure that they do not promote biofouling (e.g. polymers which biodegrade). Consideration needs to be given to predevelopment of wells that are installed using mud rotary methods. Air rotary/percussion drilling is commonly the only practical choice for installation of wells into rock.

USEPA 625/R-93/003a, 1993, EM 1110-1-4000, USEPA 570/9-75/001, 1975, USEPA 600/4-89/034, 1989, USGS (1989) TWRI, Chapter FI, Book 2, USGS (1997) WRI Report 96-4233, U.S. Army FM5-484, and ASTM D6286, provide detailed guidance for choice of appropriate drilling procedures. Drilling method should also consider locally available drilling equipment the local drillers usually have equipment that is well suited for the conditions found in the project vicinity. This can affect the project cost as well even if the local drillers use less productive equipment, they may give a better price due to familiarity with the area (less perceived risk) and the obvious low mobilization costs.

3.2.1.5 Bentonite Seal A bentonite seal should be installed in the annular space at the top of the well filter pack. This seal is installed between the filter pack and the grout discussed in the following section. Recommended hydration times for the seal should be carefully observed. By not allowing sufficient time for the bentonite seal to hydrate and form a low permeability seal, grout material could infiltrate into the bentonite seal and possibly into the filter pack. It is recommended waiting a minimum of 3 to 4 hours for hydration of bentonite pellets, or tablets when cement grout is used above the bentonite seal. If bentonite chips are used, the minimum hydration time could be twice as long. Normally chips should only be used if it is necessary to install a seal in a deep water column. Because of their high moisture content and slow swelling tendencies, chips can be dropped through a water column more readily than a material with a low moisture content, such as pellets or tablets. Bentonite chips should not be placed in the vadose zone. A 1 m (3 ft) minimum bentonite pellet seal must be constructed to protect the screen and filter pack from downhole grout migration. When installing a bentonite seal in the vadose zone (the zone above the water table), water should be added to the bentonite for it to properly hydrate. The amount of water required is dependent on the formation. It is recommended that the bentonite seal be placed in 0.15 to 0.3 m (6 in to 1 ft) lifts, with each lift hydrated for a period of 30 minutes. This method will assure that the bentonite seal is well hydrated and accomplish its intended purpose. A 0.15 to 0.3 m (6 in. to 1 ft) layer of fine to medium sand (secondary filter pack) placed atop the

bentonite seal may further enhance barrier resistance to downward grout migration.

Bentonite seals (especially those set in water) should typically be composed of commercially available pellets. Pellet seals should be 1 to 1.5 m (3 to 5 ft) thick as measured immediately after placement, without allowance for swelling. Granular bentonite may be an alternate if the seal is set in a dry condition.

The final depth of the top of the bentonite seal should be directly measured (by tape or rod) and recorded. Final depths should not be estimated, as, for example, based on volumetric measurements of placed bentonite.

3.2.1.6 Specification of Grout The annular space between the casing and the borehole wall must be filled with a grout to prevent short circuiting of water between formations and the surface. Site specific conditions should be carefully reviewed to determine the appropriate type of grout. This is particularly important for the following conditions:

- specific state regulations regarding types of grout which may be used;
- sites which include chemicals which could degrade bentonite;
- sites with geochemical conditions which could prevent setup of cement or cause exothermic reactions which could melt PVC casing;
- pressure injection wells; and
- sites with anticipated subsidence.

Grout is typically installed using the tremie method in which the grout is pumped through a side discharge pipe to the bottom of the interval to be grouted. The tremie pipe is usually raised slowly as grout is introduced. CEGS 02521 Water Wells and CEGS 02522 Ground Water Monitoring Wells provide detailed guidance regarding grout specification and installation.

1) **Cement.** Cement grout, when used in extraction/injection well construction or borehole/well decommissioning, should be composed of Type I Portland cement (ASTM C 150), bentonite (2-5% dry bentonite per 42.6 kg (94 lb) sack of dry cement) and a maximum of 23 to 26 L (6-7 gal) of approved noncontaminated-water per sack of cement. The addition of bentonite to the cement admixture will aid in reducing shrinkage and provide plasticity. The amount of water per sack of cement required for a pumpable mix will vary with the amount of bentonite used. The amount of water used should be kept to a minimum. When a sulfate resistant

grout is needed, Types II or V cement should be used instead of Type I. Neither additives nor borehole cuttings should be mixed with the grout. The use of air-entrained cement should be avoided to negate potential analytical interference in ground water samples by the entraining additives.

2) **Bentonite.** Bentonite grout is a specially designed product, which is different from a drilling fluid by its high solids content, absence of cement and its pumpability. A typical high solids bentonite grout will have a solids content between 20 and 30 percent by weight of water with a density of 9.4 pounds per gallon or greater, and remain pumpable. By contrast, a typical low solids bentonite, as used in a drilling fluid, contains a solids content between 3 and 6 percent by weight of water. The advantages of using bentonite grout include (Oliver 1997):

- Bentonite grouts, when hydrated, exert constant pressure against the walls of the annulus, leaving no room for contaminants to travel in the wall.
- Bentonite grouts are more flexible and do not shrink and crack when hydrated, creating a low permeability seal.
- Placement using bentonite grouts is much easier because more time is allowed for setting.
- Bentonite high solids grouts require less material handling than cement.
- Bentonite grouts are chemically inert, which protects personal safety, equipment, and water quality.
- Bentonite grouts have no heat of hydration making them compatible with polyvinyl chloride (PVC) casing.
- Wells constructed with bentonite grouts can be easily reconstructed if necessary.
- Cleanup of bentonite grouts is much easier than with cement grouts.

Situations where bentonite grout should not be used are when additional structural strength is needed or when excessive chlorides or other contaminants such as alcohols or ketones are present. Under artesian conditions the bentonite does not have the solids content found in a cement-bentonite grout and will not settle where a strong uplift is present. Where structural support is needed, bentonite grout does not set up and harden like a cement and will not supply the support a cement-bentonite grout will provide (Colangelo 1988).

3) **Equipment.** All grout materials should be combined in an aboveground rigid container or mixer and mechanically (not manually) blended onsite to produce a thick, lump-free mixture throughout the mixing vessel. The mixed grout should be recirculated through the grout pump prior to placement. Drill rods, rigid polyvinyl chloride (PVC) or metal pipes are suggested stock for tremie pipe. If hoses or flexible plastics must be used, they may have to be fitted with a length of steel pipe at the downhole end to keep the flexible material from curling and embedding itself into the borehole wall. This is especially true in cold weather when the coiled material resists straightening. Grout pipes should have **SIDE** discharge holes, **NOT** end discharge. The side discharge will help to maintain the integrity of the underlying material (especially the bentonite seal).

3.2.1.7 Specification of Well Headers Extraction wells in low traffic areas are commonly completed above grade for ease of maintenance and housed within a small building to limit unauthorized access and protect components from weather. In areas with high traffic or aesthetic concerns (e.g. off-site), wells are usually completed below grade with metal vaults set in concrete or concrete vaults. A common mistake is to use vaults intended for monitoring wells for extraction wells. Monitoring well vaults do not include sufficient room for valves, controls or access for maintenance work. Inaccessible equipment and poor space layout makes it impossible to service or sample wells. The vault must accommodate performance of O&M activities, as well as O&M equipment. In addition, the smaller well vaults may sit directly on well casing transferring traffic loads to the well casing and potentially causing damage. Under circumstances where extensive instrumentation, spill containment or control devices are not required, pitless adaptors and buried valves can be used to provide simple, easy to access well heads. These two objectives accomplished by predevelopment are to set the filter pack and to remove fines from the well while they are still suspended in the drilling fluids. Pumping and surging the entire length of the screen in the predevelopment phase will more efficiently develop the well and result in shorter overall development time. The traditional development that occurs 48 hours after well installation will take a much shorter time to reach parameter stabilization.

The well head or vault should be labeled with a permanent, durable, weatherproof, rust proof identification plate secured to the well casing at an easily visible location. The identification plate should show the following information:

- site name;
- well name;
- drilling contractor and driller certification;

- date well was completed;
- top of casing elevation (feet, mean sea level);
- total depth;
- casing depth (feet) and inside diameter (inches);
- screen interval (feet); and
- static water level and date measured;

The well vault or manhole should be a water tight design to protect from flooding. A concrete surface pad should be installed around each well at the same time as the outer protective casing is being installed. The size of the concrete surface pad is dependent on the casing size but should be at least 3 feet x 3 feet. Round concrete surface pads are also acceptable. The finished pad should be sloped so that drainage will flow away from the protective casing and off of the pad. Well vaults or manholes should be protected from traffic using protective steel bollards which surround the well site and which are painted a conspicuous color to aid in visibility. Well sites and vaults should be secured from unauthorized access or vandalism.

3.2.1.8 Specification of Well Development A newly completed well should not be developed for at least 48 hours after cement grout placement. This will allow sufficient time for the grout to "set" and cure before development procedures are initiated. The well should be developed as soon as practical after this time. Long delays allow any filter cake on the walls of the hole to consolidate. Wells are developed to remove formation smearing, remove drilling fluids, and to form an even gradation from aquifer materials into the filter pack (to minimize siltation). It is often useful to "pre-develop" a well after installation of filter pack but prior to installation of bentonite seals or grout. The objective of pre-development pumpage is to ensure that the filter pack is properly seated (e.g. all bridging has been removed) to minimize the potential for settling following grout installation.

There are numerous methods for well development including surge blocking, water jetting, pumpage, injection of chemicals to break down drilling fluids, use of packers to isolate developed intervals, bailing and air lifting. The elements common to all effective development programs are removal of many borehole volumes of water and movement of pumps and development tools repetitively along all portions of the screened interval. Caution should be taken when using high rate pumps or jetting tools during development because they can damage or destroy the well screen and filter pack.

It is not acceptable to assume that remedial pumpage will be sufficient to develop a well. Additional guidance on well development may be found in ASTM Standard Guide D 5521 for Development of Ground Water Monitoring Wells in Granular Aquifers. Although this ASTM guide covers the development of screened wells installed for the purpose of obtaining representative ground water information and water quality samples from granular aquifers, the methods described in the guide can also be applied to wells used for other purposes. Driscoll (1986) provides detailed discussion on well development.

3.2.1.9 Encrustation/Fouling Potential As detailed in Sections 2.1.1.2 and 2.1.3.2, mineral encrustation and biological fouling are major causes of well failure. Water quality chiefly determines the occurrence of encrustation and fouling.

Ground water normally moves slowly through aquifers, creating a quasi-chemical equilibrium between aquifer solids and dissolved ions. In some cases, the water may be nearly saturated with certain ions. In these instances, slight changes in the chemical or physical conditions can upset the equilibrium and cause precipitation of relatively insoluble materials. The chemical equilibrium is often upset by the drop in water pressure, causing mineral encrustation when the well is pumped. (Driscoll, 1986; Helweg et al., 1983; and Smith, 1995).

The causes of biological fouling are analogous to those for mineral encrustation. Ground water contains indigenous populations of microorganisms (aerobic or anaerobic). The sizes of these populations are naturally limited by factors such as nutrient concentrations, temperature and dissolved oxygen content. Many contaminants can be used by microorganisms and result in increased populations. Installation of extraction wells can further increase microbial populations through introduction of oxygen, pressure changes and temperature changes. Dramatic population increases cause a build up of biomass in well screens, filter packs and in the formation, reducing ground water extraction rates. Some microorganisms also generate a secondary mineral encrustation.

As indicated in Section 3.1.4.1, the RI/FS should include cation/anion and microbial plate count analyses to allow design of systems which minimize encrustation/fouling and to specify maintenance procedures which remove the build up which occurs. References Driscoll (1986) and Smith (1995) provide detailed guidance for interpretation of investigative data regarding this issue and for choice of strategies for preventative maintenance.

The key elements of well design which influence the buildup or removal of encrustation are as follows:

Well efficiency should be maximized. This parameter is a measure of the head loss which occurs when water enters a well (ratio of water level change in aquifer to water level change in the well). Well efficiencies of over 80% may be achieved under optimal conditions in high hydraulic conductivity aquifers. However, lower efficiencies are typical for wells in lower hydraulic conductivity (finer grained) aquifers which have less screen area. Wells with low efficiencies require more drawdown and higher entrance velocities to attain desired flow rates resulting high pressure drops, temperature changes and introduction of air into the filter pack. These effects increase the chances for fouling. Efficiency is maximized through minimization of formation damage during drilling, appropriate choice of filter pack, maximization of well screen open area, and careful choice of screen shape. Helweg (1983) provides guidance for maximizing well efficiency.

If used, drilling fluids should be carefully selected. Some drilling fluids are biodegradable polymers which break down after a few days. These polymers can cause biofouling before the well is developed that is difficult to remove (Driscoll, 1986). Phosphate compounds also should not be used.

Consider installation of chemical feed systems. If RI data indicate that encrustation may be a significant problem, it may be appropriate to install continuous chemical feed systems. These systems typically feed chemicals into a tube installed in the filter pack or preferably into small wells installed several meters from the extraction well (Driscoll, 1986 and Betz, 1992).

Choose pumps/controls which minimize cavitation, potential encrustation surface areas, heating, agitation or dramatic water level changes in the well. In addition, if investigations indicate that aerobic biomass fouling is likely, avoid air driven pumps or controllers which include bubblers or air release valves.

3.2.2 Pump Design Pump design must be carefully considered in the larger design of extraction systems. Improperly specified pumps may result in a lack of system performance and / or system upset. Therefore, pump design is critical to the success of system design.

3.2.2.1 Pump Specification Choosing the right pump for each application requires data on the type of liquids that will be pumped, the amount of both suspended and dissolved solids expected from the well, the well location and geometry, and sometimes the type of treatment system to be used to clean the contaminants from the water. For example, dual-phase liquids may be present in the wells, with the lighter phase being pumped first with one pump that will be expected to pump water later in the cleanup cycle. Alternatively, a mixture of liquids might be

pumped together. The pump must be designed for the worst case conditions. For example, the pump must be capable of lifting the heavier or more viscous liquids at the design flow rate and pressure required to transport this liquid to the treatment system. Consider choosing a pump that will support the process requirements of the treatment unit. For example, a top suction pump could be used to skim floating liquids in the well and have less water to process. A submersible centrifugal pump will mix the water and other liquids. This flow stream would be more difficult to separate in a pretreatment separator, and will produce an emulsification more difficult to treat in a biological treatment system.

In some cases, it is important to select pumps that will prevent or minimize the formation of emulsions. In these instances, the selection of pump type may have a significant effect on treatment system effectiveness. Low turbulence pumps may offer advantages over the more common submersible pump under these conditions.

Air displacement pumps can transfer liquids with a minimum of mixing, but the air in the system can lead to precipitation of minerals or oxides, that may scale the transfer piping system. Piston lift pumps with above ground drivers can work well if there is enough room above ground for the equipment. When selecting pumps, consider the maintenance of the pumping system. The system design should facilitate easy pump and ancillary equipment removal for preventative maintenance. With more moving parts down in the well, there is more work to maintain the system. CEGS 11212 Pumps, Water, Vertical Turbine contains appropriate specifications for pumps with either submersible or top mounted motors.

3.2.2.2 Liquid Specifications Characterization of the liquids to be pumped is required in a good pump specification. The design basis should include an analysis of the ground water hardness used to factor downtime, operation time, cleanup performance, and chemical costs. The possibility of bio growth should be evaluated. If suspended solids are expected, provide the maximum size and volume of solids to be pumped. If dissolved solids are expected, again the types and amounts should be specified (see Section 3.1.4.2). Solids have a tendency to plume, scale, erode, or otherwise decrease the efficiency or performance of a pump. Information on the expected levels of solids in pumped liquids can be used to predict maintenance cycles for pumps, as well as other equipment in a well. Typically, the specific chemical analysis of the ground water, as discussed in Section 3.1.4, should also be provided to the pump manufacturers. This will establish a design basis for the selection of materials for construction of the pump and related equipment.

3.2.2.3 Flow Rates The flow rate for a specific pump should be based on the results of hydrogeological modeling as detailed in Section 3.2.1.2. Each well pump should be sized to take into account possible changes due to seasonal fluctuations in aquifer characteristics, aging of the system, scaling of piping and pumps and performance of the cleanup strategies. The design flow rate should be the flow rate that will lower the water level in an extraction well or mound water in an injection well to the specified levels established in the hydrogeologic modeling. However, all pumps should be designed with a 20% margin. When practical, a pumping test should be performed to determine the possible sensitivity of flow rates from multiple wells. The pump specified should be able to pump the design flow rate at maximum efficiency, as determined by reviewing pump performance curves. Pump selection design should take into consideration the need for variable flow.

3.2.2.4 Required Head/Discharge Pressure Calculations should be based on site elevations, ground water draw down water levels, system pipe, valves, tank configurations and the maximum expected flow rate. Flexibility can easily be added to a system by installing a pump discharge flow control valve such as a pinch or globe type valve. The pressure drop for this control valve should be calculated with the valve at 70% open. This will allow a better range for turning down the system to reach the design flow expected for the system, yet allow for a flow control range to be used as the system needs or requirement may demand. As systems age, pumps and piping can scale and decrease the flow of liquids due to the increased system resistance.

3.2.2.5 Valves and Other Wellhead Requirements There are three specific needs for valves in the system. One is to isolate sections of piping so that pumps or individual well systems can be isolated for repairs or cleaning or changes in system configuration and zones of influence which may enhance cleanup. Second, flow rate control should also be considered as noted above in Section 3.2.2.3 on set flow rates from specific wells. The project may require enhancements to facilitate cleanup of problem areas, to segregate areas, or exclude selected areas from cleanup. The third is to install check valves to prevent reverse of flow back into well. Some pumps have internal check valves for pump protection, a complex system of pumps and piping that require additional check valves to minimize the back pressure on the down hole pump discharge valves. Smaller valves should be included at wellheads for sampling or testing. Each wellhead should have a provisions for water level testing equipment. Each wellhead should have accessible ports for collecting non-aerated samples or inserting probes (e.g., water levels, dissolved oxygen, pH, etc.). Well caps can have access holes and fittings, or the cap can be removable without interference to the well pumping system. As with pumps and other well equipment, the materials of construction for all wellhead and/or wetted parts

should be specified to be compatible with the water and related contaminants of the well.

3.2.2.6 Long-Term Service Considerations When evaluating pumps, consider steady-state versus cyclic operation. Avoid improper cycling of wells in tight formations, as this can cause excessive pump wear. Consider efficiency when evaluating and selecting pumps. Consider the tendency of a pump to scale under well water conditions. Materials compatible with the liquids to be pumped should be carefully specified. Chemical compatibility charts are available from pump manufacturers and should be used to specify pump materials of construction. Specify a pump that is easier to maintain. Planned obsolescence of parts and equipment, especially pumps must be taken into account. Replacement pump components should be available for inevitable shutdowns. Consider the cost of the pump in a long term maintenance life cycle analysis. Controllable, variable speed motors on pumps may provide additional flexibility.

3.2.2.7 Encrustation/Fouling Potential If RI/FS data indicate that mineral encrustation or biofouling may be a problem (Section 3.1), the design engineer should choose pumps/controls which minimize cavitation, heating, agitation or dramatic water level changes in the well. In addition, if investigations indicate that aerobic biomass fouling is likely, the designer should avoid air driven pumps or controllers which include bubblers or air release valves.

3.2.3 Piping Design Proper piping design and layout is an integral part of any successful system design. Since the piping will provide the fluid transport through all manufactured parts of the extraction / treatment and injection system, it is important that the design and layout of the piping optimize system processes.

3.2.3.1 Piping System Layout Pipe layouts should be arranged to minimize pipe lengths and support maintenance requirements. The piping system should include clean-outs at each change of direction. Where RCRA compliance is required, double containment will be used on underground piping but may be eliminated, for example, if the above ground systems are inspected daily. Use welded joint piping in place of flanges to decrease the possibility of fugitive emissions and/or drips and drops that cause the same. Slope all lines so they can be drained to clean-outs when required. Avoid low and high point traps that can collect solids or air that can reduce flow through the system. Install high point vents and low point drains on all systems.

3.2.3.2 Flow Rate Indicators/Recorders Most systems require flow rate totalizers and instantaneous readings. Where practical, install flow meters to obtain good performance data from each well. Where totalizing is not needed, consider

rotometers or similar direct reading instruments. This will then require individual flow lines from extraction wells or the area of extraction wells. Where multiple extraction wells are required, it is advantageous to have flow meters that can support operations (i.e., well/pump performance over time). A flow meter or capability to measure flow should be installed at each well. Flow meters locations and layouts should be installed per the manufacturers instructions. Improper placement can result in false readings from meters due to improper flow through piping. Consideration should be given to maintenance of meter. In long term projects, such meters may have to be replaced several times. A properly placed and easily maintained flow meter will minimize system O&M costs.

3.2.3.3 Sampling Locations Sampling locations should be considered when the piping is designed. System should have access for sampling at the extraction, transport and injection units. Sampling points should be installed at each well head, at the junction of several laterals, and up stream and down stream of the treatment unit. Figure 3 depicts typical sample location points for a ground water treatment system.

3.2.3.4 Materials of Construction Materials should be chosen based on the most concentrated level of contamination from any one well. The life expectancy of the system should be considered when erosion and corrosion are possible. Some materials may soften and fail under startup conditions, but may be acceptable when levels of contamination drop. Also consider materials for structural parts of a system and avoid materials that will corrode or otherwise fail if exposed to the contaminants in the system.

3.2.3.5 Insulation/Heating Requirements Insulated lines are primarily for personnel protection and for heat or cold conservation. Insulate lines that may be stagnant during cold weather to avoid freeze damage. Also allow for draining of lines subject to freezing. Refer to CEGS 15080 Thermal Insulation for Mechanical Systems.

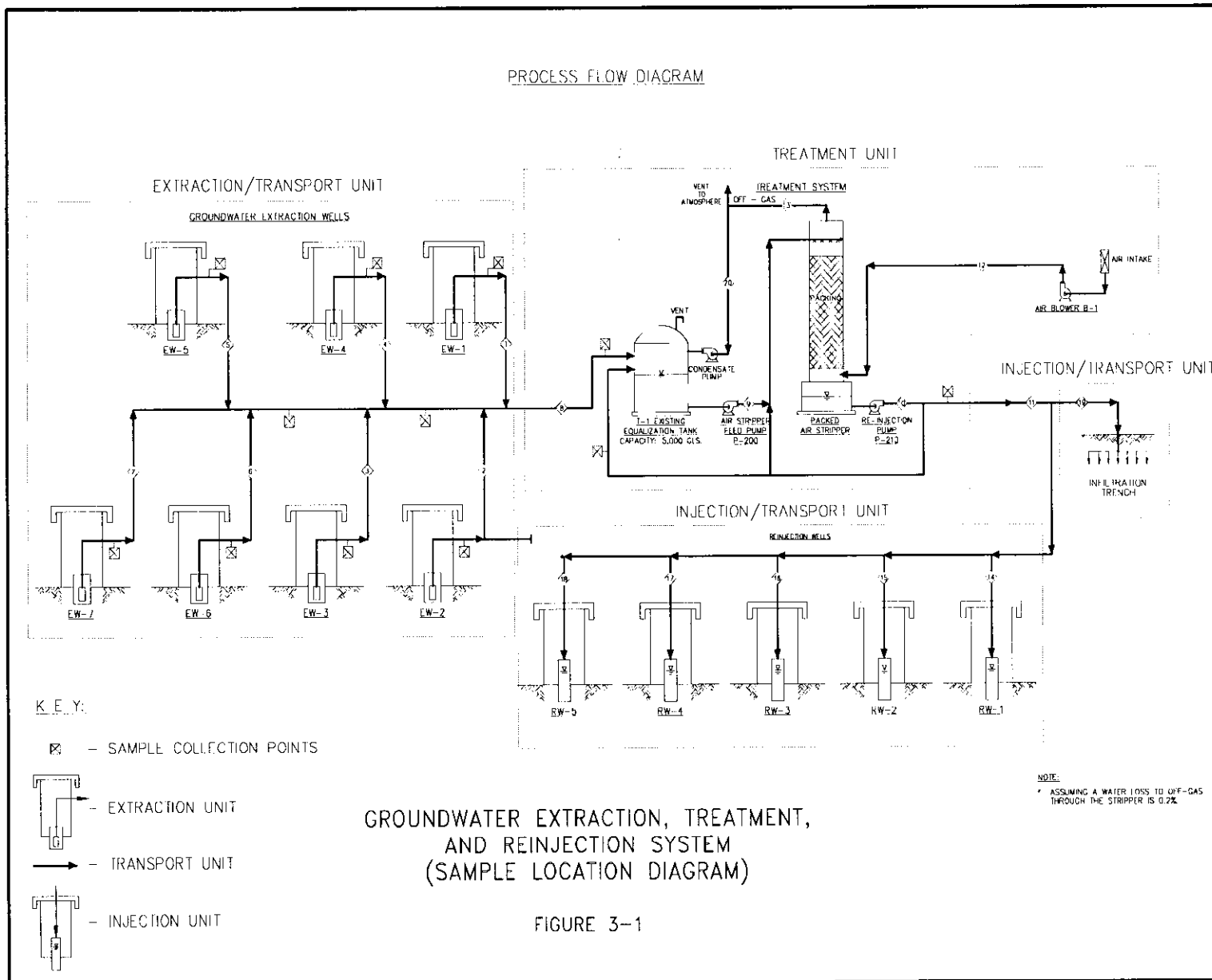

3.2.3.6 Encrustation/Fouling Potential Design pipe sizes that will not foul due to internal material buildup in a short period of time. The system should be designed to maintain fluid velocities that minimize sedimentation in points. Flow velocities should be between 2.5 and 8 ft/sec in all parts of the system. Those factors that cause a decrease in flow velocity, such as low spots or sags in lines can lead to sediment accumulation in the line which also increase the potential for plugging. Injection lines should avoid sharp 90 degree type turns before entering a well. Consideration should be given to broad curvature in injection system piping to minimize low velocity points. Do not over size lines. Install clean out fittings for line maintenance.

3.2.3.7 Manifold Locations Manifold piping to minimize pipe lengths. Design manifolds with settling velocities in mind. Slope manifold to support draining for cleaning.

3.2.3.8 Pipe Supports Pipe supports should be located according to the piping material specifications. Avoid long spans between supports to avoid sagging and resulting low and high points. Include supports that can resist water hammer and turning momentum. Allow flexibility in pipe supports to adjust for thermal expansion.

3.2.3.9 Buried/Surface/Overhead Locations Location of piping will be influenced by the applicable regulatory issues. Underground lines may need double containment and result in higher costs. Surface and overhead lines may require secondary containment if the lines are not inspected daily. It may not be advisable to route some lines carrying hazardous liquids overhead.

3.2.3.10 Valve Requirements Valve types (i.e., ball, globe, pinch, block) should be correctly chosen for their application (i.e., shutoff, modulating, block).

3.2.3.11 Flow Lines If velocities are low, solids will settle and plug lines. If lines are too small, lines may erode. Smaller lines cause high pressure losses and therefore require more power to move liquids or gases.

3.2.3.12 Head Losses Considered Equipment should be specified after all lines have been laid out. Pressure drop calculations should include losses for elevation changes, in-line valves and instruments. Accurate elevation profiles are required in this evaluation.

3.2.4 Treatment Unit Design Treatment unit design is not included in the scope of this DG. However, the following is a brief listing of key design considerations.

- Technology Options: Liquid flow and pressure from wells may be influenced by the treatment system used. Avoid high pressure requirements for well pumps. Where practical, install surge or equalization tanks before a treatment unit. The type of treatment system is influenced more by the contaminants being treated than by the extraction and injection units. However, the specifications for pumps and piping can be influenced by treatment choices.
- Influent Concentration Fluctuations: Influent concentrations in a treatment system are subject to constant variability due to inadequate characterization or inherent site variability. These fluctuations in concentrations may dictate operating conditions. Where possible install surge or equalization tanks before the treatment unit. Treatment systems designed to remediate highly contaminated water often cannot work efficiently with dilute concentrations.
- Effluent Concentration Criteria: Effluent concentration criteria: The effluent criteria for a system controls and dictates every aspect of treatment system design. A treatment system is only as effective as its ability to meet or exceed effluent concentration criteria. Specifications for extraction and injection equipment will be directly influenced by these criteria.
- Variations in well performance: Many systems obtain unexpected well yields and the designer needs to account for this possibility in the design of the treatment plant.
- Filtration Requirements: If the treatment system can not process solids, filtration will be required. It is preferable to treat solids in a process such as precipitation/coagulation and then filter solids. Good well development will set the filter pack and minimize the amount of suspended solids that will require filtration.
- Pilot Studies: Pilot studies should be performed for the intended treatment technology to ascertain its effectiveness. These studies could consist of bench scale studies, limited field trails and for vendor demonstration studies. Information gathered during this time can be critical to the successful implementation of the treatment technology.
- Treatment system objectives: Design of the treatment system should account for the likelihood that site hydrogeology and containment transport parameters will not support cleanup to MCLs or other proposed target levels. The system design should propose a method for the system to measure and

document the attainment of an asymptotic (to approach an asymptote) value which is a limitation of the system.

- Rental vs. Purchase: In some instances, it may be cost effective to consider rental of the treatment system technology. An example of this is the rental of vapor extraction system equipment for a relatively short-term duration project vs. purchase of same equipment.
- Utility Requirements/Utility availability: The availability and requirements associated with local utility service should be considered as part of treatment system design and system operating costs. As an example: a ground water pump and treatment system may require access to a local POTW for discharge of treated water if no POTW or NPDES discharge point is available.
- Space Required/Available: The location and space requirements of a treatment system should be considered. Some treatment technologies such as oil stripping, may have significant space requirements, while others such as
- The aesthetics of treatment system design on the local environment should also be considered.

3.2.5 Electrical/Control Specifications Electrical control system design is outside the scope of this DG. However, the following is a brief listing of design considerations.

The control philosophy should be established early to influence the electrical and control specifications. Remote sites may require more monitoring and telecommunication. In these cases, consider relative costs of remote telemetry against costs for on-site or on-call personnel. Automated telemetry systems can be as simple as auto-dial units which notify operators when systems have shut down to transducer/control systems which allow operators to remotely review and control flows, pressures and water levels. Telemetry systems are most useful at the following types of sites:

- small (one or two well) systems which are mechanically reliable and require little or no oversight;
- large, complicated systems at inactive facilities with little available labor;
- systems which include outlying components off-site on property not controlled by the responsible party; and
- systems conveying high concentration contaminants under pressure.

- systems that have seasonal access considerations

Systems consisting of one operating plant with daily monitoring by an on-site operator can have less automation of controls. The overall philosophy of operation should be established in the FS and expanded at the beginning of the design phase. Shutdown and emergency alarms should be incorporated to avoid contamination leaks and spills. The following factors should be considered when developing a control philosophy:

- Equipment operation should be monitored to avoid shutdown due to improper maintenance. Vapor accumulation should be monitored as necessary for plant safety. These operating philosophies are the basis for the equipment controls and can influence choices of equipment.
- Safety Requirements
- Failure Modes for Valves
- Electrical/Fire Code Requirements (NFPA 70, The National Electrical Code)
- Electrical Phase Balancing
- Alarms/Process Trips
- Automation Needs
- Startup/Shutdown Sequences

3.3 Construction The construction phase of the project is critical to overall project success. The proper planning and implementation of construction can make the difference between an optimal system and one that requires excessive maintenance or reinstallation. The oversight of a qualified geologist is required for all phases of construction of the extraction/injection well components. Refer to USACE EP 416-1-261 (1997) for the QA Representative's guide.

3.3.1 Preconstruction Review A preconstruction review is an evaluation of the specifications, materials and logistics required for construction of a system.

3.3.1.1 Specifications/Drawings Complete Specifications and drawings represent the designers' instructions for construction and a basis to compare variations and revisions. See USACE ER 1110-345-100 (1994) for design policy for military construction, and USACE ER 1110-345-700 (1997) for design analysis drawings and specifications, drawings, and construction specifications.

3.3.1.2 Constructability Review Constructability review is an opinion with regard to the ability to construct and operate the system as designed. Occasionally, the review may result in revised component sizing or location.

3.3.1.3 Spill Prevention Considered Certain contaminant/ground water mixtures are considered hazardous and thus may require spill protection such as double lined piping and retention systems around storage tanks, depending on the volume stored. Also, fuel storage and other petroleum products may require secondary containment.

3.3.1.4 Permits Obtained Permits may be required for certain construction and operation activities. Permits may be governed by State and local agencies.

3.3.1.5 Material Order Lead-Time Considered Material should be available prior to construction activities.

3.3.1.6 Equipment Decontamination Area Designated Typically, construction equipment requires decontamination prior to start work and prior to demobilization.

3.3.1.7 Safety and Health As part of the design phase, the designer must evaluate the ground water contaminant characterization data developed, and in consultation with appropriate safety and health professionals (the contractor's Certified Industrial Hygienist for contract designs, and the District's Qualified Industrial Hygiene Personnel meeting the Office of Personnel Management Standards for the Industrial Hygiene Series GS-690 for in-house designs) determine the applicability of all relevant Federal, state, and local safety and health worker protection regulations, most especially OSHA standards in general and 29 CFR 1926.65 in particular. Should the applicability of 29 CFR 1926.65 be determined based on the potential for relevant contamination exposures among workers during the construction phase, the designer, with the cooperation of the safety and health professionals, will comply with the requirements of ER 385-1-92 titled "Safety and Occupational Health Document Requirements for HTRW and OEW Activities, and draft a Health and Safety Design Analysis (HSDA) justifying as appropriate the safety and health requirements to be specified in the design specifications to the contractor. In drafting the design specifications, the designer will use CEGS 01351 "Safety, Health, and Emergency Response" in specifying to the contractor, the safety and health requirements justified in the HSDA. Note: the HTRW CX has taken the position that 29 CFR 1926.65, in and of itself, is not normally applicable during the O&M phase, with the possible exception of start-up activities, at typical pump and treat plants where the concentration of the ground water contaminants negates the reasonable possibility of O&M worker contaminant overexposures as defined by either OSHA or the

American Conference of Governmental Industrial Hygienists (ACGIH).

3.3.1.8 Silt Run-Off Control Measures Regulations may require minimization of silt runoff from construction sites. Control measures may include site grading and silt fences.

3.3.1.9 Water Source Approved for Construction It is important that water used for construction (i.e., water for mixing grout) is acceptable and does not contain substances that will react unfavorably. A chemical analysis of the water will determine if there is a potential for incompatible reactions.

3.3.1.10 Construction Waste Disposal Typically, construction will result in the production of potentially contaminated soil cuttings and ground water. Proper storage, transportation, and disposal are necessary.

3.3.1.11 Site Survey Completed A survey is advisable to properly locate and identify component locations.

3.3.1.12 Permanent Survey Benchmark Identified A permanent survey benchmark is necessary to reference component elevation and coordinates.

3.3.1.13 Critical Path Identified A critical path flow chart enables the construction oversight individual to easily identify the time-critical activities and assists in scheduling manpower and materials.

3.3.1.14 Other Scheduling Constraints Consider lead time for ordering material, equipment and labor.

3.3.1.15 Site Access Arrangements Authorization may be required from property owners or other individuals with an interest in the property.

3.3.1.16 Site Security Plan Complete A site security plan is required due to the potential of vandalism or theft of materials and equipment as well as to provide third-party safety. Proper site and well security are critical on HTRW sites.

3.3.1.17 Shift Schedules Set Systems requiring around-the-clock operation may also require 24-hour oversight.

3.3.1.18 Manpower Determined Consider the number and qualifications of individuals needed.

3.3.1.19 All Construction Techniques Specified Critical techniques such as filter pack or grout installation should be specified.

3.3.1.20 Utilities Cleared Buried and overhead utility lines must be located and cleared before construction.

3.3.2 Construction The construction phase of any extraction and treatment system project is critically important to the success of the project. Excellent system design will not mitigate inadequate construction practices. Therefore, proper oversight in the construction phase is required for system success.

3.3.2.1 Wells/Trenches

- **Construction techniques in compliance with plans/specs:** Construction must comply with the project documents for wells and trenches. Full time construction oversight should be provided by a qualified geologist or geotechnical personnel to assure strict adherence to specifications.
- **Trench supports used:** Good practice as well as OSHA regulations may require sidewall support for vertical trench construction in certain geologic formations. Trench supports may also be necessary as part of the construction if adjacent structures are present.
- **Well designation identified on wellhead:** For permanent monitoring wells, the well designation should be permanently identified on each wellhead for future reference during monitoring.
- **Well depth referenced to permanent benchmark:** Since the ground surface elevation can vary due to construction activities such as filling or grading, it is advisable to reference depth to a benchmark.
- **Materials in compliance with specifications:** Substitutions of materials called out in the drawings and specifications should be approved by the designers.
- **Wells located as shown on drawings:** Differences must be approved and documented.
- **Trenches located as shown on drawings:** Differences must be approved by the appropriate individual and documented on drawings and in writing.
- **Well casings installed as specified:** Casings must be installed at locations and to depths specified.
- **Casings designed to support wellhead equipment:** The structural capacity of the casing must be adequate for the extraction unit components.

- **Well screens installed as shown on drawings:** Material, well diameter, depth, length, and location are critical to proper operation. Differences must be approved by the authorized individual and documented on drawings and in writing.
- **Well Alignment:** After installation, verify that well alignment meets design specifications.
- **Gravel filters installed as specified:** Gravel filter construction significantly impacts well/trench performance. Filter pack should be uniform and free of fines. Filter pack may have to be field designed to match screen slot size to formation.
- **Well centralizers installed properly:** Well centralizers are required to keep the well casing in the center of the borehole during installation.
- **Bollards or other protection installed as specified:** Wellheads may require protection from traffic, mowers, etc.
- **Surface completion method according to specification:** Completion may include a concrete pad or manhole cover to maintain integrity of the well.
- **Infiltration Trench width/slope according to specifications:** Specifications and drawings are based on the designers calculation of trench volume. Differing volumes will cause performance variances. Differences must be approved by the authorized individual and documented on drawings and in writing.
- **Adequate well development, pumping tests:** May be required to determine if constructed well can meet design requirement.
- **Disinfection:** may be required.
- **Filter pack:** May need to be field designed to match screen slot size to formation. Filter pack should be free of fines.

3.3.2.2 Pumps

- **Pump Specifications:** Pump must meet the minimum contract design specifications as set forth in design drawings, and meet the designers specifications for materials and longevity. The electrical specification for all pumps must be recorded on the as-built drawings.
- **Pumps installed at specified depth:** Required for proper operation of system.

- **Foundations complete where needed:** Pumps and other equipment may require foundations.
- **Level control devices installed:** Level control devices are required for pump protection and for water level controls in tanks and wells. Level control devices will also be used as alarms to abnormal operations.
- **Injection pumps operational:** Pumps should be functioning properly after installation.
- **Storage tanks in place/not leaking:** All tanks and related fittings are to be inspected with tanks full of water and/or under operating pressure.
- **Dual-phase pumping in place:** Pumps should be properly placed (depth in well) and operational.

3.3.2.3 Piping Installation

- **Piping sloped according to specification:** Important to fluid flow, whether pumped or by gravity. Sloped lines will be easier to drain for maintenance/safety operations. Air release vents should be installed to minimize air traps.
- **Piping system maintenance:** Piping system should include cleanouts at each change in direction or low point crossovers.
- **Piping insulated as required:** Important to protect from freeze or corrosion.
- **Piping buried as required:** Burial depth is important to freeze/thaw protection and to protect the piping from vehicle traffic. Backfill procedures are important to proper loading of pipe.
- **Pipe supports per specification:** Location and spacing are important to proper pipe stress.
- **All pipe diameters and fittings as specified.** Important to maintain designed flows and pressures within specifications. Piping diameters and materials must meet specifications on project drawings.
- **Piping complete from wells to treatment system:** Hydrotest each section of pipe with clean water and check for leaks.
- **Piping complete from trenches to treatment system:** Hydrotest each section of piping with clean water and check for leaks.

- **Piping flushed/cleaned:** Pipes should be free of debris that could clog the pumps and be free of contaminants prior to startup.
- **Strainers/filters installed/cleaned:** Required for proper pump life.
- **Valves installed, operation verified:** One-way and manual valves must operate properly.
- **Pressure test complete:** Once all lines have been tested with clean water, drain the hydrotest water. Process water should not be introduced into the system until the hydrotest is completed.
- **Injection well piping:** May require terminations below static water level to minimize oxidation of water. Check valve may be required.
- **Sand traps:** May be required for some formations or poorly designed/developed wells.

3.3.2.4 Electrical and Instrumentation

- **Grounding installed/checked:** Each piece of equipment and all structures which require grounding should be tested for proper grounding to an underground grid or grounding rods.
- **Lighting/HVAC function:** Test all lighting circuits to see that lamps are operating properly. Set HVAC controls and monitor performance of the cooling and heating system for proper operation.
- **Lockouts/panels/covers in place:** Check all circuit breakers from the main disconnect through all branch circuits to insure that switches are set properly. Where tags and locks are required check for proper installation.
- **Disconnects in sight of unit being controlled:** Disconnect switches for each piece of equipment are to be in a line of sight with no obstructions.
- **Controls/alarms and interlocks functional:** Test each control loop and each alarm function to assure proper operation. Pre-operational testing should include these functions tests and a written report.
- **Power connected to monitoring devices:** All monitoring devices should be checked for proper wiring connections before power is connected to each instrument. There should be a power disconnect for each monitoring device ahead of

each device so power can be disconnected before work is done on an instrument.

- **Water Levels:** provisions should be made to measure water levels at each well
- **Flow rates:** should be monitored at each pump well to ensure accurate measurement of system performance.

3.3.2.5 Subsystems

- **Instruments calibrated:** Fluid volumes must be measured accurately to determine system performance relative to design. The gauges should be operating within the prescribed measurement range.
- **Water treatment system installed/functional:** Treated water must be cleaned by the treatment system to acceptable levels before discharge or injection.
- **Outfall/disposal systems functional:** Important to proper removal of treated water.

3.3.3 Post Construction Post construction activities and procedures can impact project implementation. These activities include important documentation of as built construction and the updating of system operation and maintenance plans.

3.3.3.1 As-Built Drawings Updated The as-built drawings document the actual dimensions and materials of the constructed system. The electrical specification for all pumps must be recorded on the as-built drawings.

3.3.3.2 As-Built Drawings Approved/Issued As-built drawings should be reviewed and approved by the engineer of record for the project.

3.3.3.3 Temporary Structures Removed To satisfy contractual conditions, all temporary facilities should be dismantled and removed from the site.

3.3.3.4 Operating Manual Ready as Reference Operating manuals should be written, reviewed and approved before systems are put into operation. The O&M should be updated after initial system shakedown to document system specific startup and shutdown procedures. The O&M should also include emergency and regular shutdown procedures. The O&M should specify what system performance data are collected, the frequency of data collection, how system performance data is to be managed, and the responsible parties for data management. The O&M must also set forth the design basis for system operation and include information such as how long the system can be allowed to be down without affecting

system performance. If the system operator understands the design basis for the system, it is more likely that the system performance goals will be met.

3.3.3.5 Maintenance Manual Ready as Reference Maintenance manuals should be written, reviewed and approved before systems are put into operation. The maintenance manual should clearly state spare parts philosophy and inventory requirements. Planned outages to replace or maintain system components should be designed into system. The maintenance plan should specify the format for all maintenance records, how the records are to be managed, record prevention practices and dictate responsibility for who will review records. The maintenance plan should provide a schedule for system maintenance, including turnaround.

3.3.3.6 Decontamination Area Cleaned Wastes should removed and the site left clean.

3.3.3.7 Project Documentation/Records At the conclusion of construction activities, project records and documentation should be reviewed and updated to reflect system baseline prior to plant startup:

- Boring/Trench Logs Submitted
- Well Construction As-Built Drawings Submitted
- Well Development Records Submitted
- All Survey Locations Recorded/Submitted
- All Geotechnical Testing Submitted
- All Pumping Test Data Submitted
- All Analytical Sampling Results Submitted

3.4 Startup/Baseline Performance It is important to baseline the performance of any system as it is brought on-line to document its performance parameters. As the performance of the system varies over time, the delta in these measured system parameters will allow the system operators to monitor performance and to troubleshoot system problems.

3.4.1 Subsurface Components

3.4.1.1 No Piping Leaks Once the piping is installed, it should be inspected for leaks. Piping leaks in wells are not a problem from a contamination point of view but they do cause a loss in pumping performance and a waste of energy.

3.4.1.2 Drawdown within Specified Tolerances After the system has been operating long enough for drawdown to stabilize, water levels should be compared to performance criteria. If the operating level in each well is above or below the predicted

level, a review by the project hydrogeologist should determine if the operating level is acceptable and if criteria or operations should be adjusted.

3.4.1.3 Monitoring Points Sample Composition within Expected Ranges Sampling from monitoring wells should begin as soon as the system has reached a steady-state condition. The sampling plan should be followed to begin the evaluations against the cleanup criteria.

3.4.1.4 Temperatures and Pressures within Expected Ranges Water temperature readings should be made as part of the sampling program. Water temperatures may influence the treatment system performance. The pressure at the well head can be used to check the operating performance of submerged pumps. Pressures and flow will change as the system reaches steady-state conditions. Adjustment may be needed to bring the operating conditions within expected ranges.

3.4.2 Pumps

3.4.2.1 Pumping test and Specific Capacity Measurement Each well should be tested for flow capacity to verify design assumptions and to set a baseline performance against which altered performance can be compared. Specific capacity should be measured by documenting steady drawdown for at least three discrete flow rates.

3.4.2.2 Flow Rates The operation of a pump can be checked by comparing the flow rate to the operating pressure. A reading of the flow and pressure can be compared to the operating predictions of the pump vendors' charts. The measured flow rate can also be compared to the design basis.

3.4.2.3 Start/Stop from All Control Mechanisms Check to see if all the pumps are pumping. Check to see that treatment system permissive signals are operating properly. Test operation of low water level cut off switch. Shutdown each well pump by removing the treatment system permissive signal. Try to pump the well down to the shutoff point. Pumps should not be allowed to run dry. Once a pump is shut down due to low water level in the well, check and record how long the pump is off before operation commences.

3.4.2.4 Current Draw/Voltage Match Specification for All Phases Each leg of power to a pump should be tested to see if the current draw is as expected. Current draw readings (amperes) should be taken after the system reaches a steady-state condition. Record and compare the readings to the predicted load expectations of vendor equipment.

3.4.2.5 No Excessive Noise/Vibration/Temperature Rise New pumps should not produce excessive noise or vibration. Either could be an indication of a pump problem or a pump that is operating off the pumps' design point. A noticeable rise in the water temperature can indicate that a pump is running hot.

3.4.2.6 Dual-Phase Systems Are Compatible with Each Other Pumps designed to remove water and lighter floating liquids need to be checked for proper operating conditions. These pumps have a narrower operating range than most pumps for best removal of floating liquids.

3.4.3 Systems

3.4.3.1 Startup/Shutdown Procedures Documented Actual startup/shutdown procedures for systems may differ from design or O&M plans due to unforeseen circumstances. During initial system operation, these procedures are refined. These actual startup/shutdown system processes must be documented and incorporated into the site O&M manual.

3.4.3.2 Control System Operates within Set Parameters Each operating condition being monitored in the control system should be tested before operations begin. Where operating conditions and recording equipment allow, check to see if the actual conditions are within expected parameters. In many cases, the actual operating conditions may be different than predictions.

Record the differences and report them to the project hydrogeologist or project engineer. If individual control loops require tuning, time should be spent adjusting the controls to reach a steady-state condition. Check to see if controls are making slow swings in achieving required operating parameters. Report any dynamic control functions that do not appear to settle down.

3.4.3.3 Instruments Hold Calibration All instruments should be tested for proper performance. Calibrate all instruments or test each instrument's accuracy against standards. Have instruments recalibrated after a short period of time to check for proper operation.

3.4.4 Baseline Measurements

Effective baseline measurements and continued performance monitoring requires measurements of all monitoring and pumping wells for flow rates, water levels, LNAPL/DNAPL levels, total well depth vacuum data, etc. It is important that these measurements are baselined at system startup and that they continue to be monitored through the life of the project to monitor system effectiveness.

3.4.4.1 Ground Water Elevation The water level in every injection, extraction or monitoring well must be measured before commencing system operation.

3.4.4.2 Flow Rate Baseline Record baseline flow rates for each well pump, the total flow to any treatment system, and the flow to the outfall or injection unit. The rate should be taken after the system reaches a steady-state condition. Adjustment may be required to improve the performance of the entire system.

3.4.4.3 Dissolved Contaminant Concentration Baseline Prior to system startup, record the dissolved contaminant concentration so that system performance can be monitored against a baseline. Baseline water levels in all wells should also be established before turning system on.

3.4.4.4 LNAPL Recovery Baseline Measuring equipment should be included to record the rate of recovery of NAPL. Record collection quantities regularly and review progress.

3.4.4.5 Water Recovery Baseline Water flow meters should be checked on a regular basis. Record flows at small intervals until flow rates are stable. Then wait longer between recording and average the flow rates to avoid misleading information from spot checking the flow rates.

3.4.4.6 Water Injection Baseline Once steady-state conditions have been reached, record and report injection flow rates. Compare to the expected rates. Also check the mounding of water in the subsurface to check against expected level. Report any discrepancies to the project hydrogeologist or project engineer.

3.4.4.7 Treatment Effectiveness Samples of water after treatment should be analyzed at short intervals at the beginning of operation. Once systems are running in a steady-state condition, tests should be performed as necessary to confirm that the systems are operating as expected or as required for permit compliance. The timing of these analyses is typically stipulated in system start-up plan or specified by regulation.

3.5 Operating Performance Operating performance is monitored to determine compliance with performance criteria specified during the FS (Section 3.2). This section summarizes specific measurements to aid in this evaluation. USEPA 600/R-94/123, 1994, provides detailed guidance on this topic. Evaluate site data during performance against system performance predictions derived from design models using a network of monitoring and extraction wells and update any model accordingly. The design verification of an extraction/irrigation system continues for months or years into system operation. The O&M contractor should know the system performance design so that they can monitor for variation in performance from design.

3.5.1 Chemical Characteristics

3.5.1.1 Concentrations at Wellheads/Trenches This information is used to establish baseline concentrations for the injection/extraction wells, to provide initial concentrations for any surface treatment system, to show areas/wells that are exceeding/meeting/below design/model predictions of concentrations at various stages of the remediation once the pumping system is activated. This information also can be used for determining/confirming the well locations as designed and the need for additional wells or extraction/injection volume to increase remediation.

3.5.1.2 Concentrations Entering Treatment System This information is used to establish a baseline concentration of ground water entering the treatment system.

3.5.1.3 Concentrations Leaving Treatment System This information is used to evaluate the performance of the treatment system to assure compliance with the effluent treatment requirements, particularly for injection or discharge. The information also is used to evaluate the operating conditions of the treatment system to modify the system or operations, if necessary, to optimize system performance. The data are used in monitoring compliance when the treated water is injected back into the aquifer. The effluent data are a useful tool for scheduling or rescheduling the maintenance program for the treatment system components.

3.5.1.4 Concentrations in Monitoring Points This is the most vital information during the remediation process which monitors the progress of the remediation system. This information provides a measure of the overall effectiveness of the remediation system. Data are collected at regular intervals and evaluated to determine if the pumping system is working efficiently or adjustment needs to be made. It is also used for reporting the effectiveness of the system.

3.5.1.5 Concentrations in Injection Water The concentrations of the injection water is useful for monitoring injection compliance and assuring a chemical balance between the injected water and the aquifer water.

3.5.2 Physical Characteristics

3.5.2.1 Ground Water Temperatures This information is useful for design and operation of surface treatment systems that require constituents/processes pre-heating (e.g. air stripping). The data also are used to assess the practicality of temperature-sensitive in-situ treatment processes such as bioremediation, air sparging, etc.

3.5.2.2 Wellhead Pressures Data on wellhead pressures are used to evaluate the operation of the pumping system. The information also provides an early warning, if a change in pressure signals the pump/piping may be failing to perform within design range.

3.5.2.3 Suspended Solids This information is used to monitor ground water extraction effectiveness and to determine if extraction activities are causing excessive drawdown of fines into well. Ground water discharged from extraction wells and added to injection wells should be analyzed for total suspended solids (TSS). This can be measured with a Rossum valve at the well head. Levels of TSS which exceed 500 mg/l may indicate that there may be excessive infiltration of fines into the extraction well.

3.5.2.4 Ambient Temperature Ambient temperature is used during operations of both in-situ and ex-situ treatment systems, to guide the design, construction and operations of various temperature protections for the piping/treatment system. Extreme temperatures also impact the performance of the pumps, instruments, valves, and similar components of the system. Temperature can also change aqueous solutions of compounds, changing the potential for scaling, and mass recovery of certain contaminants.

3.5.2.5 Water Flow Rates Flow rate is used to assess the system throughput conditions and is monitored to determine that rates meet design. Data may indicate an impact on design/permitted injection rates and discharge rates and guide adjustments to increase or decrease the extraction/injection rates. Flow rates may indicate short circuiting or impact from surface water bodies (lakes, leaking pipes, infiltration) if individual or area wells are very high or low contributors. Section 3.1.7.4 discusses interpretation of flow rate data.

3.5.2.6 Temperatures/Pressures in Treatment System Monitors the performance of the treatment system with variance from design indicates either design, construction, operations, corrosion, scaling, pipe plugging, or mechanical equipment problems.

Extreme cases of either high or low temperature and pressure may indicate significant treatment system design, operations, or maintenance and repair issues, leading to total system failure. These parameters should be monitored routinely as part of the systems O&M requirements to pinpoint root causes for non-design performance. In-situ system non-design pressure/temperature extremes can indicate a design or aquifer characterization problem(s), plugging of the aquifer, incompatibility with amendments, excessive well siltation, poor well construction (packing, purging, well breakage etc.) biofouling, corrosion, or scaling or pumps or well body.

3.5.2.7 Injection Water Temperature/Pressure Injection water temperature/pressure data monitors system operations compared to design/modeling predictions. Extremes of temperature/pressure can aggravate marginal incompatibility problems, causing formation of precipitate and reducing the injection rate. Excess temperature and pressure can rupture well casings and well heads, shorten the life of pumps, increase the rate of aquifer plugging, damage the formation, etc. and usually indicate a design or operations problem.

3.5.2.8 Ground Water Drawdown (Extraction Wells) Measurements of drawdown are used to determine compliance/ conformation with design. Excess drawdown may indicate poor characterization of the aquifer, operational problems (excess pump operation), low recharge and injection, etc. Excessive drawdown can also result from poor pump operations, poor well construction, incomplete well development, inadequate characterization of the aquifer and formation, unanticipated rapid recharge sources, inadequate well development, excess injection, etc. By monitoring and calibration, drawdown is used to optimize the remediation process. Drawdown is also used along with pumping rate to calculate specific capacity. This is one of the most important indicators of well performance and can be used as a predictor of problems. Section 3.1.7.4 discusses drawdown performance criteria.

3.5.2.9 Monitoring Point Drawdown/Mounding Excessive or inadequate monitoring point drawdown/mounding can indicate poor location of extraction/injection wells/trenches. It may also indicate impacts by other users of the aquifer, incomplete hydraulic characterization, or clogging of the formation. See USEPA 600/R-94/123 (1994), Methods for Monitoring Pump and Treat Performance.

3.5.2.10 Volume of Water Pumped Measurements of the volume of water pumped, when compared to pore volume exchange requirements are used to estimate the progress and duration of any ground water remediation program. The volume of water recovered is an overall indicator of the performance of the extraction, treatment and injection unit. This indicates if the design is appropriate and if remediation should meet schedule if all other factors are operating in the design range. Low volume recovery is a general indicator of problems and requires review of specific operational parameters to identify a specific cause or causes for the failure to meet design. Higher recovery than design volumes may indicate superior system performance but may also indicate the need to evaluate treatment capacity and performance to assure treatment. Section 3.1.7.4 discusses water balances and pore volume exchange performance criteria.

3.5.2.11 Volume of LNAPL Pumped Measurements of the volume of LNAPL recovered are compared to the estimated volume developed during the RI/FS. Data are used to track the removal of the estimated volume to determine progress and the potential end point for LNAPL treatment. Lower than design volumes of LNAPL can indicate a poor design, inadequate characterization, inadequate technology for LNAPL recovery, poor well construction, inadequate pump survey, etc. Section 3.1.7.4 discusses LNAPL recovery criteria.

3.5.2.12 Pump Amperages Pump amperages are measured to determine the "work" being done by the pumps to assess their efficiency at pumping water. Pump amperage "draw" is an indicator of the water pumped based on the "work" done by the pumps. Typically pumps will have an operating amperage range in which they are expected to operate based on the design. Pump operations outside this range may indicate poor performance by the pumps (i.e., seal leaks, mechanical wear, impeller damage, electrical short-circuiting, etc.) or inappropriate design (i.e., pump over/under sized; piping inappropriate, pumping head inappropriate for pump, etc.).

3.5.2.13 Subsidence Monitoring The O&M plan should include a schedule (typically once or twice per year) for periodic visual inspection at pre-determined benchmarks to determine if subsidence (due to consolidation of fine grain sediments which have been dewatered or collapse of voids) is occurring. Any noted anomalies should be reported immediately as set forth in the O&M plan (see Section 3.3.3.4).

3.5.3 Biological Characteristics

3.5.3.1 Dissolved Oxygen Concentrations Measurements of dissolved oxygen (DO) are used to determine if oxygen is available as an electron acceptor. DO monitoring is usually one component of monitoring programs for in-situ treatment processes, and for assessing natural attenuation. DO data can also be used to map the extent of a petroleum hydrocarbon plume. Historical DO data can be used to determine whether a petroleum hydrocarbon plume is shrinking or expanding. However, for some types of contaminants (e.g., chlorinated solvents) biodegradation typically occurs in areas where oxygen and nitrate are depleted. This distribution of oxygen concentrations vertically and horizontally in the aquifer and the changes with time indicates the effectiveness of the remedial alternative. For in-situ treatment processes, oxygen distribution data may also be used to determine whether oxygen (or electron donors) is being delivered to the desired locations, and to guide the operational strategy.

It should also be noted that there are some abiotic reactions that can result in consumption of oxygen (e.g., conversion of ferrous iron to ferric hydroxide).

3.5.3.2 Dissolved Carbon Dioxide Concentrations Measurements of dissolved carbon dioxide concentrations are collected from extracted ground water used to evaluate whether biodegradation (or some other processes) is generating carbon dioxide concentrations above background and/or injected water concentrations. Care must be taken to account for other sources such as pH changes which may increase carbonate solubilization from soils and rocks. Coupled with dissolved oxygen concentrations, the data provide an indication of in-situ biological activity. Concentrations also are indicators of the carbonate equilibrium in the ground water and the potential for scaling due to hardness, pH changes, temperature changes, etc.

3.5.3.3 Nutrient/Oxidizer Concentrations The concentrations and vertical and horizontal distribution of natural and/or injected nutrients/oxidizers determines if nutrients/oxidizers are reaching those in-situ areas as modeled or planned. These data guide changes in operations to meet design concentrations including additions of new injection and extraction wells, assess the system's performance against the plan or model, and indicate areas where excessive concentrations may be of concern. Consumption of nutrients as indicated by the analysis results and the concentration distributions can indicate areas where degradation is occurring, etc.

3.5.3.4 Water pH Measurements of pH indicate the effectiveness of any pH control (direct by injection of agents or; indirect by injected water adjusted as part of a surface treatment system) in producing the desired in-situ pH. Changes in pH generated in-situ with acidic trends indicate organic chemical degradation and thus biodegradation. Deliberate changes in pH can be used to assess the inherent buffering capacity of the aquifer system.

3.5.4 Maintenance

3.5.4.1 O&M Logs System O&M Logs should be kept for all system maintenance. The O&M Logs must provide a record of system maintenance such as equipment replacement, calibration or repair. The logs should also maintain a record of physical and/or operational changes to the system.

3.5.4.2 Replacement Parts Planned obsolescence of parts and equipment must be taken into account. Filters or other parts that have to be changed regularly must be in adequate supply. Some system components may have estimated life spans of several years, but this is significantly shorter for pumps and motors critical replacement parts should be available for the inevitable breakdowns. If there are other systems operating at the facility, the designer should consider whether any standardization of system components is possible to make O&M easier.

3.5.4.3 Lubricate All Rotating Equipment per Manufacturer's Instructions The project O&M program should identify the schedule for maintaining and lubricating all rotating equipment. The O&M program should specify the schedule, and the material to be used for maintenance and replacement, if required. The maintenance procedures should be followed and maintenance records should be kept in the project maintenance log book. Any deviation from the procedures should also should be logged.

3.5.4.4 Clean All Traps and Filters All traps and filters should be cleaned/changed as indicated by changes in pressure drops measured across the filters and per the O&M maintenance program. Changes in sand content in traps over time should be noted. Spare parts/filters should be maintained at site to minimize system disruption. Records should be retained for all maintenance activities. These filters should be disposed of in accordance with the procedures specified in the O&M manual.

3.5.4.5 Check Instrument Calibrations Instruments should be calibrated to be certain that recording/monitoring is accurate and precise to assure actual operation is in accordance with the design, remedial intent, control philosophy, and O&M manual. Calibration assures identification of damaged or otherwise inherently inaccurate instruments and their replacement in warranty. Instrument calibration records should be maintained for evaluating operational conditions and failures.

3.5.4.6 Replace System Pumps Well pumps and other rotary equipment will have finite service life that will manifest itself over the duration of the project. Pro-actively schedule pump or motor replacement on a regular basis to minimize system disruptions and maximize system uptime.

3.5.4.7 Check Control System Logic and Alarms Systematic procedures for checking control system logic and alarms prevents false alarms and alarm failures. Good design should include signaling malfunction of any critical components on an unattended pump/treatment/injection unit. Design may include interlock systems to prevent accidental releases, particularly of hazardous materials or wastes. Routine checks of the control systems and alarms assure operation as integral components of the remedial system and process. Records of maintenance performed on the control system and alarms, including failures, can enhance future evaluation(s) of the entire system and future designs.

3.5.4.8 Checks for Encrustation and Biofouling Water levels should be measured at least quarterly from each recovery well and combined with measured flow rates to calculate specific capacities (Section 2.1.1.2). These specific capacities should then be compared to baseline specific capacities measured during startup to determine if a greater amount of drawdown is required

to achieve the same extraction rate. The O&M plan should dictate (if possible) the levels to which specific capacities should decrease before action is taken. The O&M plan should dictate what tests are taken to determine if there is biological fouling. Laboratory and field testing of well water samples is typically required to evaluate the potential for encrustation (e.g., anion/cation testing). A commonly available field test kit for measuring microbial activity is the BART™ test kit. If field tests indicate that the well is biofouled, diagnostic evaluation for potential encrustation/ fouling should be performed. Diagnostic work may include analysis of extraction well water samples for cation/anion or microbial plate counts. If the drop in specific capacity is significant, pump systems may be pulled from the well and inspected for evidence of encrustation/fouling. Alternately, a camera survey of the well may be performed. In wells with a high degree of biofouling, a down hole camera may be ineffective due to reduced visibility from suspended organic matter.

Potential encrustation/fouling should be addressed as soon as identified, even if the reduction of system performance is still within acceptable tolerances. This is because removal of encrustation/fouling after performance has fallen below acceptable levels is usually orders of magnitude more expensive and difficult than when addressed during early stages.

TABLE 3-3

Considerations for System Design

System Component/Feature	Problems to Avoid	Preventative Measures
Well Placement	Recovery well outside of plume	Proper plume/capture zone characterization - use appropriate groundwater flow models for well network design
	Poor access/inability to workover well	Design system for periodic maintenance
	Excessive recharge from surface water	Ensure that capture zones are sufficiently far from surface water bodies
Well Design	Inappropriate screened interval resulting in groundwater and/or NAPL extraction rates lower than planned	Characterize hydrogeology for system design - use slug tests performed in relevant screened interval as design basis.
	Misses heavily contaminated zone	Proper hydrogeologic characterization prior to design/installation - use soil data from continuous coring as design basis. Consider using nested extraction wells.
	Inappropriate well diameter	Select optimum size based upon hydrogeology/system design/pump size and other measuring devices
	Inadequate well development	Appropriate well development method (surge wells in addition to pumping)- consider multiple well development events in silty soils.
Horizontal Wells	Depth control/changes in aquifer depth	Establish stratigraphy across projected extraction well area
	Installation of filter pack	Often difficult. Ensure that horizontal well is most appropriate for situation.
	Well development	Properly develop well - often difficult for horizontal wells
Screen-General	Mineral encrustation in groundwater with high calcium (Ca ⁺), magnesium (Mg ⁺²), and carbonate (CO ₃ ⁻²). Precipitation occurs due to changes in geochemistry caused by high water velocities through the well screen.	Select the well screen material, slot size, and pumping rate to ensure that the linear groundwater velocity entering the well is less than 0.1 ft/sec.

TABLE 3-3, Continued
Considerations for System Design

System Component/Feature	Problems to Avoid	Preventative Measures
<p>NOTE: Avoid use of PVC in pressure injection wells, extraction wells in low transmissivity formations (wire wrapped steel screens provide a higher hydraulic efficiency) and at sites with incompatible contaminants.</p>	<p>Biological fouling. Occurs primarily in ground water with high dissolved iron and/or manganese (e.g., greater than 5 ppm).</p>	<p>This is a difficult problem to avoid. Accurately measure iron and manganese before designing the well field. Select largest appropriate screen slot size. Select pumping rate that does not entrain air in the extracted groundwater (i.e., ensure that the water level in the well does not drop below the well screen). Avoid placement of wells in areas of high organic loading such as near septic leach fields. Consider installing air sparging wells around extraction well to precipitate iron and manganese <i>in situ</i> (i.e., the Vyredox process). Consider designing the well(s) with an automated cleaning system (e.g., acid rinsing).</p>
	<p>Physical erosion of screen/slots. High groundwater entrance velocities can cause groundwater with high mineral concentrations to react with steel well screens. PVC can be dissolved by a variety of NAPLs.</p>	<p>As with mineral encrustation, select the steel well screen slot size and groundwater pumping rate to ensure that the linear groundwater velocity entering the well is less than 0.1 ft/sec. Do not use PVC where incompatible NAPLs may be present.</p>
	<p>Siltation. Can occur in any well, but is most prevalent in wells that use inappropriate sand packs and/or are not developed well.</p>	<p>Proper design/selection of screen and filter pack (i.e., <u>do not</u> just rely on the well drillers' judgement); proper well development is critical; provide a minimum 1-foot sump at bottom of well to collect silt.</p>
<p>Pumps-Electric Submersible</p>	<p>Loss of pump down hole</p>	<p>Use a separate support cable to hang pumps. Do not use discharge line for support.</p>
	<p>Cavitation</p>	<p>Match pump selection to the anticipated recharge rate of the well (i.e., do not use an oversized pump); place pump low enough in the water column to maintain sufficient recharge rate; use in-well level sensors to control pump.</p>

TABLE 3-3, Continued

Considerations for System Design

System Component/Feature	Problems to Avoid	Preventative Measures
Pumps-Electric Submersible (continued)	Electric motor failure -- often occurs due to overheating when pumping capacity exceeds water flow rate (recharge) into well.	Match pump selection to the anticipated recharge rate of the well (i.e., do not use an oversized pump); select pumping rate to minimize on/off cycling frequency; consider pneumatic pumps for average pumping rates less than 5 gpm. <u>Do not</u> use electric pumps if average pumping rate is below or near low flow rating of pump. For pump installations that make pulling the pump from the well difficult, use 3-wire pumps instead of 2-wire pumps. 3-wire pumps have separate, surface mounted control boxes that contain the pump start and run capacitors that can be serviced easily.
	Run-dry failures and excessive cycling	Match pump selection to the anticipated recharge rate of the well (i.e., do not use an oversized pump). Keep well screen free of obstruction (e.g., fouling). Use conductivity probes (inherently safe) for level control unless there is high (>5 ppm) dissolved iron in the groundwater which can precipitate and foul the sensor. Sleeve the conductivity sensor to prevent it from contacting the side of the well. Place the pump below the sensor ground in the well when using conductivity probes for level control, thereby acting as a failsafe by causing the pump to shut off before the well is "dry".
Pumps-pneumatic surface mounted for groundwater (e.g., double diaphragm pumps)	Freezing in cold weather; also can freeze if expanding air vents near liquid tubing	Heat or select more up-to-date design or use submersible (more expensive) pumps.
	Diaphragm or seal failure	Ensure material compatibility with contaminants, particularly if NAPL may be present.

TABLE 3-3, Continued

Considerations for System Design

System Component/Feature	Problems to Avoid	Preventative Measures
Pumps-pneumatic submersible for groundwater	Emulsion of discharge	Pump selection criteria should include a preference for low turbulence pumps.
	Air entrainment of water	Proper selection of pneumatic pumping system if entrained air is from compressor, i.e., more modern designs prevent mixing of compressed air and groundwater)
	Dirty air clogging valves	Proper design of air delivery system -- use oil-less compressor or filter compressed air.
	Encrustation of internal controller	Proper pump selection. As with well screen encrustation, ensure that pumping results in flow rates less than 0.1 ft/sec in high CO ₃ ground water to avoid mineral precipitation.
	Fouled poppet valves due to siltation in the pump chamber	Use a well intake screen to filter silt entrained in the groundwater and slow build-up of silt in the pump chamber. Regular maintenance of the pump in high silt ground water. Regular/thorough re-development of the extraction well.
Pumps-hydrocarbon	Venting of air into well	Run air discharge lines to outside vent
	Pumps too much water	Raise pump inlet into NAPL layer
	Low hydrocarbon recovery rates	Consider vacuum enhancement
Piping	Water line freezing	Avoid low spots/traps; slope pipes toward extraction wells to drain during pump off-cycles; heat trace and insulate; low point drains
	Material incompatibility with contaminants	Proper selection of materials; flexible hose may be chemically compatible and light so that it is easily managed in the field.
	Encrustation/fouling	As with well screen encrustation, ensure that pumping results in flow rates less than 0.1 ft/sec in high CO ₃ ground water to avoid mineral precipitation. Provide access points to clear/clean lines.
	Pipe Failure	Select appropriate bedding material and cover thickness; proper size and location of pipe hangars and supports
	Siltation	Proper pipe sizing; maintain proper and continuous pitch and avoid low spots/traps

TABLE 3-3, Continued

Considerations for System Design

System Component/Feature	Problems to Avoid	Preventative Measures
Compressed Air Systems	Overheating	Proper compressor sizing; maintain cooling capacity, air circulation and room ventilation; minimize on/off cycling
	Water Condensation	Design proper water removal equipment (i.e., air dryer, desiccants, and collection or surge tanks)
	Excessive cycling of compressor	Allow for sufficient air tank capacity in design
Air Lines/Meters	Contaminated with construction dirt	Clear before final assembly
	Excessive moisture in air leading to rusting pipes and freezing of pipelines	Plastic or stainless pipes and air dryer installation
Transfer Storage Tanks	Sediment build up	Effective well design and well development; include appropriate settling or filtration component and access parts for cleaning out sediment
	Corrosion	Proper material selection
	Overflowing	Selection and coordination of appropriate level and flow controls; evaluate/balance system flows
	Foaming in tank	Design to minimize water aeration (e.g., locate inlet below free liquid surface)
Instrumentation	Level control fouling/encrustation	Specify routine preventative maintenance or non-contact sensors such as proximity or ultrasonic
	Inaccurate level controls	Equipment selection; proper selection of measurement locations, consider pump size and placement with respect to well screen
	Foaming interfering with sensors or detectors	Evaluate foaming potential prior to design and incorporate measures to limit foaming such as sleeved sensors; use non-contact sensors such as proximity or ultrasonic
	Flow totalizer fouling or encrusted	As with well screen encrustation, ensure that pumping results in flow rates less than 0.1 ft/sec in high CO ₃ ground water to avoid mineral precipitation. Select appropriate meters; install in areas to that are easily accessed for preventative maintenance

TABLE 3-3, Continued
Considerations for System Design

System Component/Feature	Problems to Avoid	Preventative Measures
Injection Wells	Fouling/Encrustation	Use drop pipe to reduce aeration of water. Add treatment chemicals to retard the formation of precipitates; design wells/trenches to allow cleaning and maintenance
	Flooding due to inadequate infiltration capacity	Include additional capacity (factor of safety) to account for unavoidable reduction in infiltration rate due to clogging from sedimentation or precipitation. Use slug tests performed in relevant screened interval as design basis.

APPENDIX A

REFERENCES

A-1. Required Publications

a. U.S. Army Corps of Engineers (USACE)

- CEGS 1351. Safety, Health and Emergency Response.
- EM 1110-1-4005. Engineering and Design-In-situ Air Sparging.
- EM 200-1-2. Technical Project Planning (TPP) Process.
- EM 200-1-3. Requirements for the Preparation of Sampling and Analysis Plans Ch. 1.
- EM 1110-1-502. Technical Guidelines for Hazardous and Toxic Waste Treatment and Cleanup Activities.
- EM 1110-1-4000. Monitoring Well Design, Installation, and Documentation at Hazardous and/or Toxic Waste Sites, Eng. 5056A-R.
- EP 415-1-261. QA Representative's Guide, Vol.5.
- ER 385-1-92. Safety and Occupational Health Document Requirements for Hazardous, Toxic and Radioactive Waste (HTRW) and Ordinance & Explosive Waste (OEW) Activities.
- ER 1110-345-700. Design Analysis, Drawings and Specifications.
- ER 1110-1-263. Chemical Data Quality Management for HTRW Activities.
- ER 1110-1-1300. Cost Engineering Policy and General Requirements.
- ER 1165-2-132. Hazardous, Toxic and Radioactive Waste (HTRW) Guidance for Civil Works Projects.
- ER 1110-345-100. Design Policy for Military Construction.

OM 25-1-51. Guidance for Preparation and Processing of Publications within HQUSACE/OCE.

TM 5-813-1. Water Supply: Sources and General Conditions.

b. U.S. Department of the Interior (USDOI)

U.S. Department of the Interior, 1981. Ground Water Manual. U.S. Government Printing Office, Washington, DC, 480 pp.

U.S. Geological Survey, 1997. Water Resources Investigation (WRI) Report 96-4233, Guidelines and Standard Procedures for Studies of Ground-Water Quality: Selection and Installation of Wells and Supporting Documentation.

U.S. Geological Survey, 1989. Techniques of Water Resource Investigations (TWRI), Application of Drilling, Coring, and Sampling Techniques of Test Holes and Wells, Chapter F1, Book 2.

c. U.S. Environmental Protection Agency (USEPA)

USEPA 430/9-78/009, 1978. Innovative and Alternative Technology Assessment Manual.

USEPA 510/R-96/001, 1996. How to Effectively Recover Free Product at Leaking Underground Storage Tank Sites: A Guide for State Regulations.

USEPA 530/SW-89/1031, 1989. RFI Guidance four Volumes NTIS #PB89-2000299, OSWER Directive 9502.00-6D.

USEPA 530/UST-88/001, 1988. Cleanup of releases from petroleum USTs: Selected technologies, Washington, DC, 110 pp.

USEPA 530/SW-89/026, 1989. Statistical Analysis of Groundwater Monitoring Data at RCRA Facilities Interim Final Guidance Document NTIS PB89-151-047.

USEPA 530/SW-89/031, May 1989. Soil, Groundwater and Subsurface Gas Releases, RCRA Facility Investigation (RFI) Guidance, IV.

- USEPA 530/SW-89/031, May 1989. Soil, Groundwater and Subsurface Gas Releases, RCRA Facility Investigation (RFI) Guidance, III.
- USEPA 530/SW-89/031, May 1989. Soil, Groundwater and Subsurface Gas Releases, RCRA Facility Investigation (RFI) Guidance, II.
- USEPA 530/SW-89/031, May 1989. Soil, Groundwater and Subsurface Gas Releases, RCRA Facility Investigation (RFI) Guidance, I.
- USEPA 540/G-87/004 1987. Data Quality Objectives for Remedial Response Activities, Example Scenario: RI/FS Activities at a Site with Contaminated Soils and Groundwater, OSWER Directive 9355.0-7B.
- USEPA 540/G-89/004, Oct. 1988. Guidance for Conducting Remedial Investigations and Feasibility Studies Under CERCLA, Interim Final, NTIS# PB89-184626, OSWER Directive 9355.3-01.
- USEPA 540/S-92/001. Chemical Enhancements of Pump and Treat Remediation.
- USEPA 540/R-92/071a, 1992. Guidance for Conducting Treatability Studies Under CERCLA.
- USEPA 542/B-95/002, 1995. Guide to documenting cost and performance for remediation projects.
- USEPA 570/9-75/001, 1977. Manual of water well construction practices. Office of Water Supply, Washington, DC.
- USEPA 600/2-77/240, 1977. An Introduction to the Technology of Subsurface Wastewater Injection.
- USEPA 600/4-89/034, 1989. Handbook of Suggested Practices for the Design and Installation of Ground Water Monitoring Wells.
- USEPA 600/8-90/003, 1990. Basics of Pump-and-Treat ground Water Remediation Technology.
- USEPA 600/2-93/118, 1993. Compilation of groundwater models.

R.S. Kerr Environ. Res. Lab., Ada, OK.

USEPA 600/R-94/039a, 1994. The Hydrocarbon Spill Screening Model (HSSM) Volume 1: User's Guide, R.S. Kerr Environ. Res. Lab., Ada, OK.

USEPA 600/R-94/123, 1994. Methods for Monitoring Pump-and-Treat Performance.

USEPA 600/S8-87/013, 1987. State-of-the-Art Report: Injection of Hazardous Wastes Into Deep Wells (Project Summary).

USEPA 625/6-85/006, 1985. Handbook-Remedial Action at Waste Disposal Sites.

USEPA 625/9-89/007, 1989. Injection Well Mechanical Integrity.

USEPA 625/R-93/003a, 1993. Subsurface Characterization and Monitoring Techniques: A desk reference guide. Vol. 1..

USEPA OSWER Directive 9283.1-06, 1992. Considerations in Ground Water Remediation at Superfund Sites and RCRA Facility Update.

d. American Society of Testing and Materials (ASTM)

ASTM (D88). Standard Test Method for Saybolt Viscosity.

ASTM (D445). Standard Test Method for Kinematic Viscosity of Transparent & Opaque Liquids (the Calculations of Dynamics Viscosity)

ASTM (D971). Standard Test Method for Interfacial Tension of Oil Against Water by the Ring Method.

- ASTM (D2487). Standard Classification of Soils for Engineering Purposes (Unified Soil Classification System).
- ASTM (D2488). Standard Practice for Description and Identification of Soils (Visual-Manual Procedure).
- ASTM (2974). Standard Methods for Moisture, Ash and Organic Matter of Peat and other Organic Soils.
- ASTM (5518). Standard Guide for Acquisition of File Aerial Photography & Images for Establishing Historic Site-use and Specifications.
- ASTM (5730). Standard Guide for Width and length of pressure Sensitive Tape.
- ASTM (D6286). Standard Guide for Selection of Drilling Methods for Environmental Site Characterization.

e. Other

Monitoring Well Optimization

- Abdul, A.S., S.F. Kia, and T.L. Gibson, 1989. Limitations of monitoring wells for the detection and quantification of petroleum products in soil and aquifer. Ground Water Monitoring Review, 9(2): 90-99.
- Abdul, A.S., 1992. A new pumping strategy for petroleum product recovery from contaminated hydrogeologic systems: Laboratory and field evaluations. Ground Water Monitoring Review, 9(2); 90-99.
- Colangelo, R. V., 1988. Inert Annular Space Materials, the Acid Test. Ground Water Monitoring Review, Spring.
- ANSI/AWWA A-100-97, 1997. AWWA Standard for Water Wells.
- ANSI/AWWA 1-100. American Water Works Association Standard (Water Wells).
- ANSI/ASAE EP400.1, 1989. Designing and Constructing Irrigation Wells, 5pp.
- Bouwer, H. and Rice, 1976. A Slug Test Method for Determining-Hydraulic Conductivity of Unconfined Aquifers

with Completely or Partially Penetrating Wells. Water Resources Research, Vol. 12, No. 3, 423-428.

Helweg, Otto, Verne H. Scott, and Joseph C. Scalmanini, 1983. Improving Well and Pump Efficiency. American Water Works Association, Denver, CO, 168 pp.

Oliver, R., 1997. Bentonite Grouts vs. Cement Grouts, National Drillers Buyers Guide, May.

Olsthoorn, T.N., 1987. The Clogging of Recharge Wells. Netherlands Water Works Testing and Research Institute. Communications No. 72, Rijswijk, Netherlands, 31pp.

USEPA 600/R-04/168a, 1994. Hydrologic Evaluation of Landfill Performance (HELP): Model User's Guide for Version 3 (NTIS #PB95-212692).

Remediation

API (American Petroleum Institute), 1989. A guide to the assessment and remediation of underground petroleum releases, Washington, DC, 81 pp.

Betz, 1992. Betz Handbook of Industrial Water Conditioning. Betz Laboratories, Inc., Trevose, Pennsylvania, 391 pp.

Charbeneau, R.J., P.B. Bedient, and R.C. Loehr, eds., 1992. Groundwater Remediation, Water Qual. Mgmt. Library, Vol. 8. Technomic Publishing Co., Lancaster, PA, 185 pp.

Committee on Groundwater Cleanup Alternatives, 1994. Alternatives for Ground Water Cleanup. National Academy Press Washington, D.C., 315 pp.

Dragun, Ph.D., James, 1998. The Soil Chemistry of Hazardous Materials. The Hazardous Materials Control Research Institute. 458 pp.

Drever, James I., 1982. The Geochemistry of Natural Waters. Prentice-Hall, Inc., Englewood Cliffs, 388 pp.

Driscoll, Fletcher G, 1986. Groundwater and Wells, 2nd Edition. Johnson Division, St. Paul, Minnesota, 1088 pp.

- Frey, J. Hilton, Kathleen A. Shelton, and Isidoros J. Zanicos, 1994. Is Pump And Treat The Best Solution? *Environmental Protection*, 5(7):24-27.
- Hem, John D., 1983. Study and Interpretation of the Chemical Characteristics of Natural Water, 2nd ed., U.S. Government Printing Office, 363 pp.
- Kruseman, G.P., 1990. Analysis and Evaluation of Pumping Test Data, 2nd, ed., Publication 47. International Institute for Land Reclamation and Improvement, 377 pp.
- Norris, R.D., R.E. Hinchee, R. Brown, P.L. McCarty, L. Samprini, J.T. Wilson, D.H. Kampbell, M. Reinhard, E.J. Bower, R.C. Borden, T.M. Vogel, J.M. Thomas, and C.H. Ward, 1994. Handbook of Bioremediation. Lewis Publishers, Boca Raton, FL, 257 pp.
- Raghunath, H.M., 1982. Groundwater-Hydrogeology. Groundwater Survey and Pumping Tests. Rural Water Supply and Irrigation Systems. John Wiley & Son, New Delhi, India, 459 pp.
- Smith, Stuart A., 1995. Monitoring and Remediation Wells: Problem Prevention, Monitoring, and Rehabilitation. Lewis Publishers, Boca Raton, FL, 183 pp.
- Todd, David Keith, 1980. Groundwater Hydrology, 2nd ed., John Wiley & Sons, Inc., 535 pp.
- Wisconsin Dept. of Natural Resources, Aug 1993. Guidance for Design, Installation and Operation of Groundwater Extraction and Product Recovery Systems. PUBL-SW183-93, Madison, WI, 35 pp.
- Zheng, C., Bennett, G.D., and C.B. Andrews, Nov. 1991. Analysis of Groundwater Remedial Alternatives at a Superfund Site. *Ground Water*, 29(6): 838-848.

Fate and Transport

- Bear, J., 1972. Dynamics of Fluids in Porous Media. American Elsevier Publishing Co., New York, 763 pp.
- Farr, A.M., R.J. Houghtalen, and D.B. McWhorter, 1990. Volume

estimation of light nonaqueous phase liquids in porous media. *Ground Water*, 28(1):48-56.

FLOWPATH, 1994. (version 5.0, Waterloo Hydrogeologic Software, developed by Nelson Guiguer and Thomas Franz).

Freeze, R. Allan, and John A. Cherry, 1979. Groundwater. Prentice-Hall, Inc., Englewood Cliffs, 604 pp.

Riwoni, M.D., and Banerjee P., 1989. Sorption of Volatile Organic Solvents From Aqueous Solution Onto Subsurface Solids. *J. Contam. Hydrol.*, 4:168-179.

NAPL/Hydrocarbons

Fetter, C. W. 1994. Applied Hydrogeology. 3rd Edition. Merrill Publishing Company. Prentice Hall, Englewood Cliffs, NJ, 691 pp.

A-2. Related Publications

a. Design and Construction

CEGS 02521. Water Wells Guide Specification for Military Construction.

CEGS 02522. Ground Water Monitoring Wells, Guide Specification for Military Construction of Water Wells.

CEGS 11211. Pumps: Water, Centrifugal

ER 1110-345-720. Construction Specifications.

FM 5-484. Multiservice Procedures for Well-Drilling Operations.

Walton, William C., 1988. Groundwater Pumping Tests: Design and Analysis. Lewis Publishers, Boca Raton, FL.

Wiedemeier, T., M.A. Swanson, D. E. Moutoux, J.T. Wilson, D.H. Kampbell, J.E. Hansen, and P. Haas, Sept 1996. Overview of the Technical Protocol for Natural Attenuation of Chlorinated Aliphatic Hydrocarbons in Groundwater Under Development for the Air Force Center for Environmental

Excellence. Proc. USEPA Symp. on Natural Attenuation of Chlorinated Organics in Groundwater, Dallas, TX, 169 pp.

Wilson, J.L. and S.H. Conrad, 1984. Is physical displacement of residual hydrocarbons a realistic possibility in aquifer restoration?, in Proc. NWWA/API Conf. on Petroleum Hydrocarbons and Organic Chemical in Ground Water: Prevention, Detection, and Restoration. Natl. Ground Water Assoc., Dublin, OH, 274-298.

b. Monitoring Well Optimization

Bierschnenk, W. H., 1964. Determining Well Efficiency by Multiple Step-Drawdown Tests, Publication 64. International Association of Scientific Hydrology, 493-507.

Blake, S.B., and R.A. Hall, 1984. Monitoring petroleum spills with wells: Some problems and solutions, in Proceedings. Fourth Natl. Symp. on Aquifer Restoration and Ground Water Monitoring, Natl. Ground Water Assoc., Dublin, OH, 236 pp.

Boyd, G.R., and K.J. Farley, 1992. NAPL removal from groundwater by alcohol flooding: Laboratory studies and applications, in Hydrocarbon Contaminated Soils and Groundwater, Volume 2. edited by E.J. Calabrese and P.T. Kosteci, Lewis Publishers, Boca Raton, FL, 437-460.

Brown, M.J., D.R. Burris, J.A. Cherry, and D.M. Mackay, 1992. Enhancement of organic contaminant retardation by the modification of aquifer material with cationic surfactants, in proc. Subsurface Restoration Conf., Dallas, TX, Rice Univ., Dept. of Environ. Sci. & Eng., Houston, TX, 194-196.

Chiang, C.Y., K.R. Loos, and R.A. Klopp, 1992. Field determination of geological/chemical properties of an aquifer by cone penetrometry and headspace analysis. Ground Water, 30(3):428-436.

Chiang, C.Y., J.P. Nevin, and R.J. Charbeneau, 1990. Optimal free hydrocarbon recovery from a single pumping well, in Proc. Conf. on Petroleum Hydrocarbons and Organic Chemicals in Ground Water: Prevention, Detection, and Restoration. Natl. Ground Water Assoc., Dublin, OH, 161-

178.

Cohen, R.M., A.P. Bryda, S.T. Shaw, and C.P. Spalding, 1992. Evaluation of visual methods to detect NAPL in soil and water. *Ground Water Monitoring Rev.*, 12(4):132-141.

Danielson, R.E., and P.L. Sutherland, 1986. Porosity. In: A. Klute (ed.) *Methods of Soil Analysis. Part 1.* 2nd ed. *Agronomy* 9:443-461.

Demond, A.H., and P.V. Roberts, 1991. Effect of interfacial forces on two-phase capillary pressure-saturation relationships. *Water Resource Res.*, 27(3): 423-437.

Dumford, D., J. Brookman, J. Billica, and J. Milligan, 1991. LNAPL distribution in a cohesionless soil: A field investigation and cryogenic sampler. *Ground Water Monitoring Rev.*, 11(3):115-122.

Dutton, Alan R., April 1994. Toxic Substances and the Hydrologic Science. A selection of papers presented at the conference held in Austin, Texas, American Institute of Hydrology.

Faust, C.R., R.J. Guswa, and J.W. Mercer, 1989. Simulation of three-dimensional flow of immiscible fluids within and below the unsaturated zone. *Water Resource Res.*, 25(12):2449-2464.

Ferrand, L.A., P.C.D. Milly, and G.F. Pinder, 1989. Experimental determination of three-fluid saturation profiles in porous media. *J. Contam. Hydrol.*, 4:373-395.

c. Remediation

Artrip, Gail. Superfund's Presumptive Remedy. *Pollution Engineering*, 28(2): 48-49.

ASTM (D420). Standard Guide to Site Characterization for Investigating and Sampling Soil and Rock for Engineering Purposes.

ASTM (D421). Standard Practice for Dry Preparation of Soil Samples for Particle-Size Analysis and Determination of Soil Constants.

- ASTM (D422). Standard Method for Particle-Size Analysis of Soils.
- ASTM (D854). Standard Test Method for Specific Gravity of Soils.
- ASTM (D1140). Standard Test Methods for Amount of Material in Soils Finer than the No. 200 (75- μ m) Sieve.
- ASTM (D2216). Standard Test Methods for Laboratory Water (Moisture) Content of Soil, Rock and Soil-Aggregate Mixtures, Laboratory Determination of.
- ASTM (D2285). Standard Test Method for Interfacial Tension of Electrical Insulating Oils of Petroleum Origin Against Water by Drop-Weight Method.
- ASTM (D2325). Standard Practice for Capillary-Moisture Relationships for Coarse-and Medium-Textured Soils by Porous-Plate Apparatus.
- ASTM (D2434). Standard Practice for Permeability of Granular soils (Constant Head).
- ASTM (D3152). Standard Test Methods for Capillary-Moisture Relationship for Fine-Textured Soils by Pressure-Membrane Apparatus.
- ASTM (D4318). Standard Test Method for Liquid Limit, Plastic Limit, and Plasticity Index of Soils.
- ASTM (D4404). Standard Test Method for Determination of Pore Volume and Pore Volume Distribution of Soil and Rock by Mercury Intrusion Porosimetry.
- ASTM (D4564). Standard Test Method for Soil Bulk Dry Density.
- ASTM (D4643). Standard Test Method for Water (Moisture) Content of Soil by the Microwave Oven Method, Determining.
- ASTM (E1195). Standard Test Methods for Determining a Sorption Constant (KOC) for an Organic Chemical in Soil and Sediments.

- Borden, R.C., and C.M. Kao, 1992. Evaluation of groundwater extraction for remediation of petroleum-contaminated aquifers. *Water Environ. Res.*, 64(1):28-36.
- Brown, R. et al., 1991. The Use of Aeration in Environmental Cleanups, in the Proceedings of the NWWA/API 1991 Conference on Petroleum Hydrocarbons and Organic Chemicals in Groundwater.
- Hall, S.H., Luttrell, S.P., and Cronin, W.E., 1991. A Method for Estimating Effective Porosity and Groundwater Velocity. *Ground Water*, 29(2):171-174.
- Hudak, P.F., K.M. Clements, and H.A. Loaiciga, 1993. Water-table correction factors applied to gasoline contamination. *J. Environ. Eng.*, 119(3):578-584.
- Mercer, J.W., and R.M. Cohen, 1990. A review of immiscible fluids in the subsurface: Properties, models, characterization, and remediation. *J. Contam. Hydrol.*, 6:107-163.
- Page, A.L. (ed.), R. H. Miller (ed.), and D. R. Keeney (ed.), 1982. *Methods of Soil Analysis, Chemical and Microbiological Properties Second Edition, Part 2. Agronomy* 9:29-3.5.
- Pantazidou, M., and N. Sitar, 1993. Emplacement of nonaqueous liquids in the vadose zone. *Water Resource Res.*, 29(3):705-722.
- Satkin, R.L., and Bedient, P.B., August 1988. Effectiveness of Various Aquifer Restoration Schemes Under Variable Hydrogeologic Conditions. *Ground Water*, 26(4):488-497.
- Sims, R.C., 1990. Soil remediation techniques at uncontrolled hazardous waste sites. *J. Air Waste Manage. Assoc.*, 40(5):704-730.
- TM 5-814-7. Hazardous Waste Land Disposal/Land Treatment Facilities (Paragraph 5-5 Deep Well Injection).
- USEPA 540/R-94/012, Feb. 1994. Contract Laboratory Program National Functional Guidelines for Organic Data Review.
- USEPA 600/2-90/011, 1990. Assessing UST corrective action

technologies: Site assessment and selection of unsaturated zone treatment technologies. Risk Red. Eng. Lab., Cincinnati, OH.

USEPA 600/2-90/027, 1990. Assessing UST corrective action technologies: Early screening of cleanup technologies for the saturated zone. Risk Red. Eng. Lab., Cincinnati, OH

USEPA 600/K-93/002, 1993. Bioremediation of Hazardous Waste Sites Practice Approaches to Implementation.

USEPA 600/S8-88/008, 1988. Laboratory Protocol for Determining Fate of Waste Disposed in Deep Wells.

USEPA 625/4-91/026, 1991. Seminar publication: Site characterization for subsurface remediation. R.S. Kerr Environ. Res. Lab., Ada, OK.

USEPA 625/R-94/003, 1994. Manual: Alternative methods for fluid delivery and recovery. Risk Red. Eng. Lab., Cincinnati, OH.

USEPA (OSWER Directive 9355.4-03) Oct. 1989. Considerations in Ground Water Remediation of Superfund Sites, NTIS# PB91-238584.

Wiedemeier, T., J.T. Wilson, D.H. Kampbell, R.N. Miller, and J.E. Hansen, 1995. Technical Protocol for Implementing Intrinsic Remediation with Long-Term Monitoring for Natural Attenuation of Fuel Contamination Dissolved in Groundwater. Air Force Center for Environmental Excellence, Technology Transfer Division, Brooks AFB, San Antonio, TX.

d. Fate and Transport

Abdul, A.S., 1988. Migration of petroleum products through sandy hydrogeologic systems. Ground Water Monitoring Review, 8(4): 73-81.

Ballestero, T.P., F.R. Fiedler, and N.E. Kinner, 1994. An investigation of the relationship between actual and apparent gasoline thickness in a uniform sand aquifer. Ground Water, 32(5):708-718.

- Banerjee, S., 1984. Solubility of organic mixtures in water. Environ. Sci. Technol., 18(8):587-591.
- Geller, J.T., and J.R. Hunt, 1993. Mass transfer from nonaqueous phase organic liquids in water-surfaced porous media. Water Resource, 29(4):833-845.
- Evans, O.D., and G.M. Thompson, 1986. Field and interpretation techniques for delineating subsurface petroleum hydrocarbon spills using soil gas analysis, in Proc. NWWA/API Conf. on Petroleum Hydrocarbons and Organic Chemicals in Ground Water: Prevention, Detection, and Restoration. Natl. Ground Water Assoc., Dublin, OH, 444-455.
- McDonald, M. G. and A. W. Harbaugh, 1988. A modular three-dimensional finite-difference ground-water flow model (MODFLOW), (TWI 06-A1), 576 pp.
- Kaluvarachchi, J.J., and J.C. Parker, 1989. An efficient finite element model for modeling multiphase flow in porous media. Water Resource Res., 25(1):43-54.
- Terzaghi, K., 1942. Soil moisture and capillary phenomena in soils. In: O.E. Meinzer (ed.) Hydrology. McGraw Hill Book Co., New York, 331-363.
- USEPA 530/SW-87/006, 1987. Batch-Type Adsorption Procedures for Estimating Soil Attenuation of Chemicals, Draft Technical Resource Document, NTIS PB87-146155..
- USEPA 540/4-90/053, 1990. Basic concepts of contaminant sorption at hazardous waste sites. Ground Water, R.S. Kerr Environ. Res. Lab., Ada, OK.
- USEPA 540/2-90/011, 1990. Subsurface contamination reference guide, Washington, DC.
- USEPA 600/M-91/009, 1991. Solubility, sorption, and transport of hydrophobic organic chemicals in complex mixtures, Environmental Research Brief, R.S. Kerr Environ. Res. Lab., Ada, OK.
- USEPA 600/2-91/020, 1991. MOFAT: A two-dimensional finite element program for multiphase flow and multicomponent

transport, program documentation and users guide. R.S. Kerr Environ. Res. Lab Ada, OK, NTIS PB91-191692.

USEPA 600/R-92/247, 1992. LNAPL distribution and hydrocarbon vapor transport in the capillary fringe. R.S. Kerr Environ. Res. Lab., Ada, OK.

USEPA 625/4-89/019, 1989. Seminar Publication: Transport and Fate of Contaminants in the Subsurface..

e. NAPL/Hydrocarbons

API (American Petroleum Institute), 1988. Phase separated hydrocarbon contaminant modeling for corrective action, Publ. 4474. Washington, DC, 125 p.

Charbeneau, R.J., N. Wanakule, C.Y. Chiang, J.P. Nevin, and C.L. Klein, 1989. A two-layer model to simulate floating free product recovery: Formulation and applications, in Proc. Conf. on Petroleum Hydrocarbons and Organic Chemicals in Ground Water: Prevention, Detection, and Restoration. Natl. Ground Water Assoc., Dublin, OH, 333-345.

Feenstra, S., D.M. Mackay, and J.A. Cherry, 1991. A method for assessing residual NAPL based on organic chemical concentrations in soil samples. Ground Water Monitoring Rev., 11(2):128-136.

Gruszczenski, T.S., 1987. Determination of a realistic estimate of the actual formation product thickness using monitor wells: A field bailout test, in Proc. Conf. on Petroleum Hydrocarbons and Organic Chemicals in Ground Water: Prevention, Detection, and Restoration. Natl. Ground Water Assoc., Dublin, OH, 235-253.

Hall, R.A., S.B. Blake, and S.C. Champlin, Jr., 1984. Determination of hydrocarbon thicknesses in sediments using borehole data, in Proc. Fourth Natl. Symp. on Aquifer Restoration and Ground Water Monitoring. Natl., Ground Water Assoc., Dublin, OH, 300-304.

Hampton, D.R., and H.G. Heuvelhorst, 1990. Designing gravel packs to improve separate-phase hydrocarbon recovery: Laboratory experiments, in Proc. Conf. on Petroleum

Hydrocarbons and Organic Chemicals in Ground Water: Prevention, Detection, and Restoration. Natl. Ground Water Assoc., Dublin, OH, 195-209.

Hampton, D.R., M.M. Smith, and S.J. Shank, 1991. Further laboratory studies of gravel pack design for hydrocarbon recovery wells, in Proc. Conf. on Petroleum Hydrocarbons and Organic Chemicals in Ground Water: Prevention, Detection, and Restoration. Natl. Ground Water Assoc., Dublin OH, 615-629.

Hampton, D.R., and P.D.G. Miller, 1988. Laboratory investigation of the relationship between actual and apparent product thickness in sands, in Proc. Conf. on Petroleum Hydrocarbons and Organic Chemicals in Ground Water: Prevention, Detection and Restoration. Natl. Ground Water Assoc., Dublin, OH, 157-181.

Hayes, D., E.C. Henry, and S.M. Testa, 1989. A practical approach to shallow petroleum hydrocarbon recovery. Ground Water Monitoring Rev., 9(1):180-185.

Hughes, J.P., C.R. Sullivan, and R.E. Zinner, 1988. Two techniques for determining the true hydrocarbon thickness in an unconfined sandy aquifer, in Proc. Conf. on Petroleum Hydrocarbons and Organic Chemicals in Ground Water: Prevention, Detection and Restoration. Natl. Ground Water Assoc., Dublin, OH, 291-314.

Hunt, W.T., J.W. Wiegand, and J.D. Trompeter, 1989. Free gasoline thickness in monitoring wells related to ground water elevation change, in Proc. Conf. on New Field Techniques for Quantifying the Physical and Chemical Properties of Heterogeneous Aquifers. Natl. Ground Water Assoc., Dublin, OH, 671-692.

Huyakom, P.S., Y.S. Wu, and S. Panday, 1992. A comprehensive three-dimensional numerical model for predicting the fate of petroleum hydrocarbons in the subsurface, in Proc. Conf. on Petroleum Hydrocarbons and Organic Chemicals in Ground Water: Prevention, Detection, and Restoration. Natl. Ground Water Assoc., Dublin, OH, 239-253.

Kaluarachchi, J.J., J.C. Parker, and R.J. Lenhard, 1990. A numerical model for areal migration of water and light hydrocarbon in unconfined aquifers. Adv. in Water

Resource, 13:29-40.

Keech, A.K., 1988. Hydrocarbon thickness on groundwater by dielectric piping well logging, in Proc. Conf. on Petroleum Hydrocarbons and Organic Chemicals in Ground Water: Prevention, Detection and Restoration. Natl. Ground Water Assoc., Dublin, OH, 275-290.

Kemblowski, M.W., and C.Y. Chiang, 1990. Hydrocarbon thickness fluctuations in monitoring wells. Ground Water, 28(2):244-252.

Klute, A., 1986. Water retention: Laboratory methods. In: A. Klute (ed.) Methods of soil analysis. Part 1. 2nd ed. Agronomy 9:635-662.

Leinonen, P.J. and D. Mackay, 1973. The multicomponent solubility of hydrocarbons in water. Can. J. Chem. Eng., 51:230-233.

Parker, J.C., and Lenhard, R.J., 1990. Estimation of Free Hydrocarbon Volume from Fluid Levels in Monitoring Wells. Ground Water, 28(1):57-67.

Sullivan, C.R., R.E. Zinner, and J.P. Hughes, 1988. The occurrences of hydrocarbon on an unconfined aquifer and implications for liquid recovery, in Proc. Conf. on Petroleum Hydrocarbons and Organic Chemicals in Ground Water: Prevention, Detection, and Restoration. Natl. Ground Water Assoc., Dublin, OH, 135-156.

Testa, S.M., D.L. Winegardner, and C.B. Burris, 1992. Reinjection of coproduced groundwater in relation to LNAPL occurrence, in Proc. Conf. on Petroleum Hydrocarbons and Organic Chemicals in Ground Water: Prevention, Detection, and Restoration. Natl. Ground Water Assoc., Dublin, OH, 127-145.

Testa, S.M., and M.T. Paczkowski, 1989. Volume determination and recoverability of free hydrocarbon. Ground Water Monitoring Rev., 9(1):120-128.

USEPA 540/S-95/500, July 1995. Light Nonaqueous Phase Liquids.

- Wickramanayake, G.B., N. Gupta, R.E. Hinchee, and B.J. Nielsen, 1991. Free petroleum hydrocarbon volume estimates from monitoring well data. *J. Environ. Eng.*, 117(5):686-691.
- Yaniga, P.M., 1984. Hydrocarbon retrieval and apparent hydrocarbon thickness: Interrelationships to recharging/discharging aquifer conditions, in *Proc. NWWA/API Conf. on Petroleum Hydrocarbons and Organic Chemicals in Ground Water: Prevention, Detection, and Restoration*. Natl. Ground Water Assoc., Dublin, OH, 299-329.
- Yaniga, P.M., and JG Warburton, 1984. Discrimination between real and apparent accumulation of immiscible hydrocarbons on the water table: A theoretical and empirical analysis, in *Proc. Fourth Natl. Symp. and Expo. on Aquifer Restoration and Ground Water Monitoring*. Natl. Ground Water Assoc., Dublin, OH, 311-315.
- Zinner, R.E., E.A. Hodder, W.E. Carroll, and C.A. Peck, 1991. Utilizing groundwater reinjection in the design of a liquid hydrocarbon recovery system, in *Proc. Conf. on Petroleum Hydrocarbons and Organic Chemicals in Ground Water: Prevention, Detection, and Restoration*. Natl. Ground Water Assoc., Dublin, OH, 469-483.

f. Electrical

- CEGS 01450. Chemical Data Quality Control.
- CEGS 13080. Seismic Protection for Mechanical, Electrical Equipment.
- CEGS 15080. Thermal Insulation for Mechanical Systems.
- CEGS 16311. Main Electric Supply Station and Substation.
- CEGS 16370. Electrical Distribution System, Aerial.
- CEGS 16375. Electrical Distribution System, Underground.
- CEGS 16415. Electrical Work, Interior.
- CEGS 16475. Coordinated Power System Protection.

CEGS 16528. Exterior Lighting Including Security and CCTV Applications.

CEGS 16610. Uninterruptible Power Supply (UPS) System Above 15kVA Capacity.

TM 5-811-1 0310. Electric Power Supply and Distribution.

TM 5-811-2 0023. Electrical Design, Interior Electrical System.

TM 5-811-3 0021. Electrical Design: Lighting and Static Electricity Protection.

TM 5-811-6 0134. Electric Power Plant Supply.

TM 5-811-7 6100. Electrical Design, Cathodic Protection.

TM-5-811-14 0076. CEMP Coordinated Power Systems Protection.

National Fire Protection Association, 1996. No. 70 National Electrical Code, NEC-70-96LL. ITP Delmar Publishers.

g. Other

ER 385-1-92. Safety and Occupational Health Document Requirements for Hazardous, Toxic and Radioactive Waste (HTRW) Activities.

ER 500-1-20. Corrective Action Program (CECAP).

Montgomery, John, H. (ed.), and Linda M. Welkom (ed.), 1990. Groundwater Chemicals Desk Reference. Lewis Publishers, Chelsea, MI,

USEPA 600/2-79/170, 1979. Radius of Pressure Influence of Injection Wells.

APPENDIX B

**TABLE B-1
 REMEDIAL INVESTIGATION/DESIGN BASIS CHECKLIST**

Checklist Item	Yes	No	Source of Data
SITE CONDITIONS Topography Adjacent Land Use Climate Well Search Nearby Receptors Access to Utilities Subsidence Potential Site-Specific Geologic Conditions Site Drainage Conditions			
SITE CONTAMINATION Source of Contamination Age of Contamination Soil Contamination			

TABLE B-1, Continued
REMEDIAL INVESTIGATION/DESIGN BASIS CHECKLIST

Checklist Item	Yes	No	Source of Data
GROUNDWATER			
Soil/Type/Description			
Stratigraphy			
Depth to Water/Seasonal and Tidal Fluctuations			
Confining Layer/Depth			
Total Porosity			
Specific Yield (Effective Porosity)			
Grain Size			
Bulk Dry Density			
Buffering Capacity			
Hydraulic Conductivity (Permeability Coefficient)			
Thickness of Capillary Fringe			
Microbial Assays			
Organic Carbon Content			
Ground Water Flow Direction/Velocity			
Groundwater Recharge			
Partitioning Coefficients			

TABLE B-1, Continued
REMEDIAL INVESTIGATION/DESIGN BASIS CHECKLIST

Checklist Item	Yes	No	Source of Data
HYDROGEOLOGY/SOIL CHARACTERIZATION			
Cations/Anions			
Total Dissolved Solids			
Total Suspended Solids			
Total Volatile Solids			
PH			
Oxidation-Reduction Potential			
Total Organic Carbon			
Biological Oxygen Demand			
Chemical Oxygen Demand			
Temperature Range			
Nitrogen and Phosphorus			
Microbial Assays			
Toxicity Tests			
Conductivity			
Dissolved Oxygen			
Hardness as Calcium Carbonate			

TABLE B-1, Continued
REMEDIAL INVESTIGATION/DESIGN BASIS CHECKLIST

Checklist Item	Yes	No	Source of Data
NAPL CHARACTERIZATION			
Source			
Density			
Viscosity			
Solubility			
LNAPL/Water Interfacial Tension			
Areal Extent			
Rate of Movement			
Apparent Thickness			
Formation Parameters			
REGULATORY/PERMITS			
Lead Agency			
Other Agency Involvement			
Permits			

**TABLE B-2
 FEASIBILITY STUDY CHECKLIST**

Checklist Item	Yes	No	Source of Data
DESIGN BASIS Cleanup Goals Containment Goals Plume Size/Configuration Construction Division Involvement Soil Contamination Areal Extent Contaminant Mass/Volume Pathways/Receptors Analysis Concentrations of Contaminants at Extraction Locations (Actual long term pump test wells) Remediation Targets Cleanup Duration Constraints			
PERFORMANCE CRITERIA Extent of Hydraulic Capture Water Balance Pore Volume Exchange Rate Dissolved Mass Recovery Rates and Mass Balance LNAPL Recovery Rates Concentration Trends			

DG 1110-1-1
12 Nov 99

Amount of Drawdown			
--------------------	--	--	--

TABLE B-3
DESIGN CHECKLIST

Checklist Item	Yes	No	Source of Data
EXTRACTION/INJECTION SYSTEM DESIGN Screen Length and Depth Casing Materials and Diameter Screen Type Sand Pack Type Drilling Procedures Grout Well Headers Well Development O&M Plan Oversight Plan/Funding			
PUMP DESIGN Pump Specification Liquid Specifications Flow Rates Required Head/Discharge Pressure Valves and Other Wellhead Requirements Long-Term Service Considered Encrustation/Fouling Potential			

DG 1110-1-1
12 Nov 99

O&M Plan			
----------	--	--	--

**TABLE B-3, Continued
 DESIGN CHECKLIST**

Checklist Item	Yes	No	Source of Data
PIPING DESIGN Piping System Layout Flow Rate Indicators/Recorders Materials of Construction Insulation/Heating Requirements Manifold Locations Pipe Supports Buried/Surface/Overhead Locations Valve Requirements Flow Lines Head Loss Considered Cleanout Locations Considered			
TREATMENT SYSTEMS Technology Options Filtration Requirements Feasibility Study Results Concentration Fluctuations Rental vs. Purchase Utility Requirements Local Utility Availability Space Required/Available			

TABLE B-3, Continued
DESIGN CHECKLIST

Checklist Item	Yes	No	Source of Data
ELECTRICAL/CONTROL Control Philosophy/Logic Remote Monitoring Safety Requirements Failure Modes for Valves Electrical/Fire Code Requirements Electrical Phase Balancing Alarms/Process Trips Automation Needs Startup/Shutdown Plans Required			

TABLE B-4
CONSTRUCTION CHECKLIST

Checklist Item	Yes	No	Source of Data
PRECONSTRUCTION REVIEW			
Specifications/Drawings Complete			
Construction Division Involvement			
Constructability Review			
Spill Prevention Considered			
Permits Obtained			
Material Order Lead-Time Considered			
Equipment Decontamination Area Designated			
Health & Safety Plan Developed			
Silt Run-Off Control Measures			
Water Source Approved for Construction			
Construction Waste Disposal			
Site Survey Completed			
Permanent Benchmark Identified			
Critical Path Identified			
Other Scheduling Constraints			

DG 1110-1-1
12 Nov 99

Site Access Arrangements			
Site Security Plan Complete			

**TABLE B-4, Continued
 CONSTRUCTION CHECKLIST**

Checklist Item	Yes	No	Source of Data
PRECONSTRUCTION REVIEW, Cont. Shift Schedule Set Manpower Determined Union Issues Resolved All Construction Techniques Specified Utilities Cleared			
CONSTRUCTION <u>Wells/Trenches :</u> Construction Techniques in Compliance with Plans/Specs Full Time Oversight by Qualified Engineer or Geologist Trench Supports Used Well Location Identified on Wellhead Well Depth Referenced to Permanent Benchmark Materials in Compliance with Specifications Wells Located as Shown on Drawings Trenches Located as Shown on Drawings Well Casings Installed as Specified Casings Designed to Support			

DG 1110-1-1
12 Nov 99

Wellhead Equipment			
--------------------	--	--	--

**TABLE B-4, Continued
CONSTRUCTION CHECKLIST**

Checklist Item	Yes	No	Source of Data
<p>CONSTRUCTION <u>Wells/Trenches, Continued:</u></p> <p>Well Screens Installed as Shown on Drawings</p> <p>Well Centralizers Installed Properly</p> <p>Bollards or Other Protection Installed as Specified</p> <p>Surface Completion Method According to Specifications</p> <p>Trench Width/Slope According to Specifications</p>			
<p><u>Pumps:</u></p> <p>Pumps Installed at Specified Depth</p> <p>Foundations Complete Where Needed</p> <p>Level Control Devices Installed</p> <p>Injection Pumps Operational</p> <p>Storage Tanks in Place/Not Leaking</p> <p>Dual-Phase Pumping in Place</p> <p>Full Time Oversight Submittals Required</p>			
<p><u>Piping Installation:</u></p> <p>Piping Sloped According to Specification</p>			

DG 1110-1-1
12 Nov 99

Cleanouts Installed Per Specification			
--	--	--	--

**TABLE B-4, Continued
CONSTRUCTION CHECKLIST**

Checklist Item	Yes	No	Source of Data
<p><u>Piping Installation, Continued:</u></p> <p>Piping Insulated as Required</p> <p>Pipe Supports Per Specification</p> <p>Piping Complete From Wells to Treatment</p> <p>Piping Complete From Trenches to Treatment</p> <p>Piping Flushed/Cleaned</p> <p>Strainers/Filters Installed/Cleaned</p> <p>Valves Installed, Operation Verified</p> <p>Pressure Test Complete</p>			
<p><u>Electrical:</u></p> <p>Grounding Installed/Checked</p> <p>Lighting/HVAC Functional</p> <p>Lockouts/Panels/Covers in Place</p> <p>Disconnects in Sight of Unit Being Controlled</p> <p>Controls/Alarms Functional</p> <p>Power Connected to Monitoring Devices</p>			

**TABLE B-4, Continued
 CONSTRUCTION CHECKLIST**

Checklist Item	Yes	No	Source of Data
<u>Electrical Subsystems:</u> Instruments Calibrated Water Treatment System Installed/Functional Outfall/Disposal Systems Functional			
POST CONSTRUCTION As-Built Drawings Updated As-Builts Approved/Issued Temporary Structures Removed Operating Manual Ready as Reference Decontamination Area Cleaned			
SUBSURFACE No Piping Leaks Drawdown Within Specified Tolerance Monitoring Points Compositions Within Expected Ranges Temperatures and Pressures Within Expected Ranges			
PUMPS Pump Test and Specific Gravity Measurement Flow Rates			

Start/Stop From All Control Mechanisms			
---	--	--	--

**TABLE B-4, Continued
CONSTRUCTION CHECKLIST**

Checklist Item	Yes	No	Source of Data
<p>PUMPS, Continued</p> <p>Current Draw/Voltage Match Specification for All Phases</p> <p>No Excessive Noise/Vibration/Temperature Rise</p> <p>Dual-Phase Systems are Compatible with Each Other</p>			
<p>SYSTEMS</p> <p>Control System Operates Within Set Parameters</p> <p>Instruments Hold Calibrations</p> <p>Observed and Followed Published Startup/Shutdown Plans</p>			

TABLE B-5

STARTUP/BASELINE PERFORMANCE CHECKLIST

Checklist Item	Complete	Date
BASELINE Flow Rate Baseline NAPL Recovery Baseline Water Recovery Baseline Water Injection Baseline Treatment Effectiveness		

TABLE B-5, Continued
STARTUP/BASELINE PERFORMANCE CHECKLIST

Checklist Item	Expected	Measured
CHEMICAL CHARACTERISTICS Concentrations at Wellhead(s)/Trench(es) Concentrations Leaving Treatment System Concentrations in Monitoring Points Concentrations in Injection Water		
PHYSICAL CHARACTERISTICS Ground Water Temperatures Wellhead Pressures Ambient Temperature Water Flow Rates Temperatures/Pressures in Treatment System Injection Water Temperature/Pressure Ground Water Drawdown Monitoring Point Drawdown/Mounding Volume of NAPL Pumped Pump Amperages		

TABLE B-5, Continued
STARTUP/BASELINE PERFORMANCE CHECKLIST

Checklist Item	Expected	Measured
BIOLOGICAL CHARACTERISTICS Dissolved Oxygen Concentrations Dissolved Carbon Dioxide Concentrations Nutrient Concentrations Water pH		
MAINTENANCE Lubricate all Rotating Equipment per Manufacturer's Instructions Clean all Traps and Filters Check Instrument Calibrations Check Control System Logic and Alarms Checks for Encrustation and Biofouling		

APPENDIX C

LIST OF ACRONYMS

API American Petroleum Institute
ASTM American Society for Testing and Materials
CERCLA Comprehensive Environmental Response and Liability
Act
CMS Corrective Measures Study
DG Design Guide
DNAPL Dense Non-Aqueous Phase Liquids
DO Dissolved Oxygen
DOC Dissolved Organic Carbon
FS Feasibility Study
GC/MS Gas Chromatograph/Mass Spectrometer
gpm gallons per minute
GWE Ground Water Extraction
HTRW Hazardous, Toxic, and Radioactive Waste
LNAPLS Light Non-Aqueous Phase Liquids
MCLs Maximum Contaminant Levels
meg/L Milliequivalents per liter
mg/L Milligrams per liter
MSC Major Subordinate Commands
NAPL Non-Aqueous Phase Liquids
Non-DOD..... Non Department of Defense
O&M Operations and Maintenance
OEW Ordinance and Explosive Waste
ORP Oxidation-Reduction Potential
OSHA Occupational Safety and Health Administration
POTW Publicly Owned Treatment Works
PVC Plastic Vinyl Casing
RCRA Resource Conservation Recovery Act
RFI RCRA Facility Investigation
RI Remedial Investigation
TDS Total Dissolved Solids
TOC Total Organic Carbon
TSS Total Suspended Solids
UIC Underground Injection Control
USACE United States Army Corps of Engineers
USCS United Soil Classification System
USEPA United States Environmental Protection Agency